



ALSANIT®



ALTUS

ALTUS

CE

ALTUS full-height cubicles

Available in:

- MFC** - Laminated chipboard
- HPL** - High Pressure Laminate
- SP** - Sandwich panels

Complementary products

page 6 →

Description:

Full-height toilet cabins are becoming increasingly popular because they not only guarantee privacy but also allow for better coherence between sanitary interiors and the overall appearance of the building. This makes this type of WC cubicles increasingly applicable in newly constructed facilities.

The design of full-height cabins is executed considering the space and character of the rooms. However, proper preparation and finishing of the rooms before in-

stallation are important, as this system is entirely prepared at the ALSANIT factory and maintains small dimensional tolerances. Any deviations from the specified dimensions may hinder installation.

Due to its proven construction and high-quality materials, the ALTUS system performs excellently in restrooms with high traffic volume.

- only Torx screws are used
- doors opening outward or inward
- hinges with gravity self-closing
- very high durability
- taylor made to individual dimensions



Full-height cabins



CE certificate valid throughout the European Union



Fittings with a brushed steel finish



Fittings developed by ALSANIT are manufactured in Poland at the company headquarters



Production on CNC machines ensures precision and short lead times

Standard dimensions

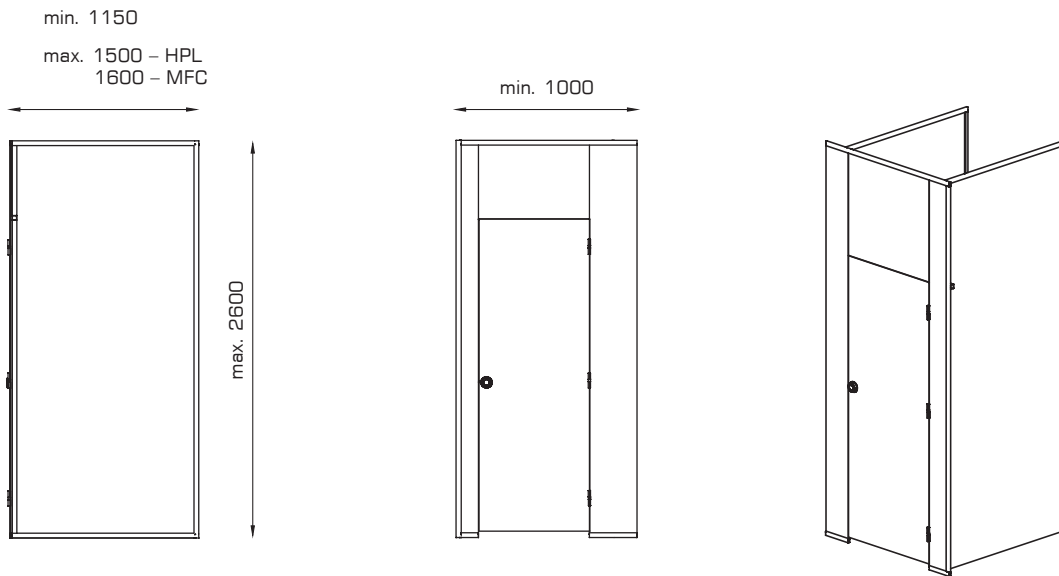

Standard equipment

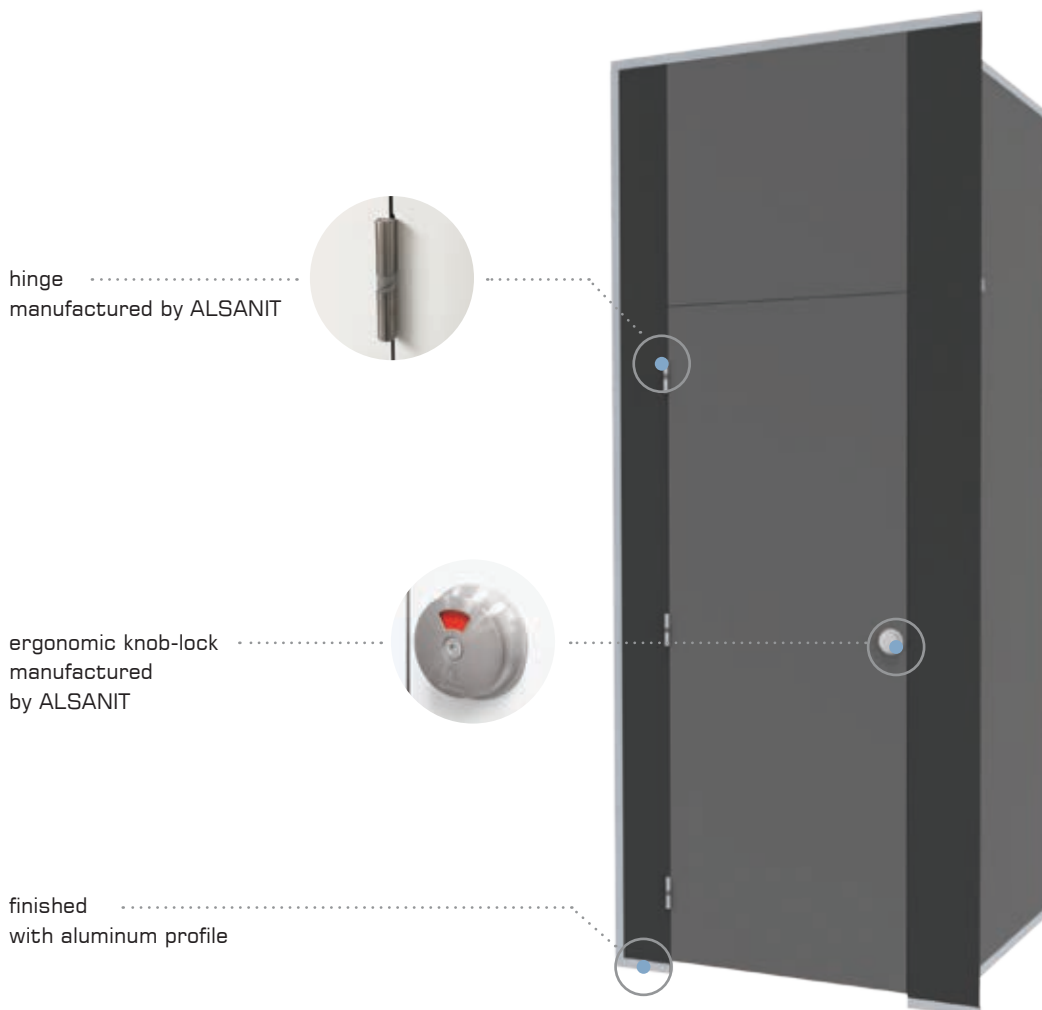

available
colors

page 14 →



ALTUS construction details

Construction details:

Hinges

- tested durability: 200,000 open/close cycles
- typically for ALSANIT, mounted to narrow edges of panels
- made of brushed steel with a polyamide insert
- gravity self-closing
- minimalist appearance
- optionally - hinges for internal doors not visible from the outside

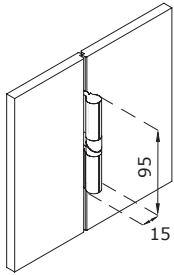

Knob-locks

- elegant, ergonomic and highly durable
- emergency opening capability
- universal for left/right doors
- bolt rotation angle of 360°
- „click” every 90°
- easy to use, including for individuals with disabilities
- white-red occupancy indicator

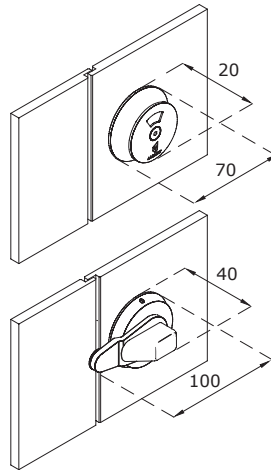

Support-legs (Optionally)

- made of brushed steel
- ensure easy leveling of partitions
- for 10-18 mm boards mounted to the side of the board, for 28 mm and thicker boards screwed into the core
- adjustment range +/- 20 mm
- rosette mounted on two dowels, covered with a plate

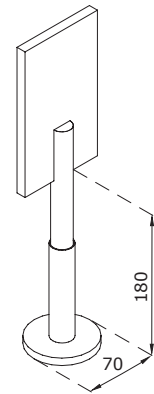

Types of panels available for the system:

MFC

Laminated chipboard

18 mm

28 mm

MFC is compressed under high temperature and pressure using binding agents with wood chips. The top layer is a decorative melamine coating.

- edges are finished with durable edging using HOT-AIR technology (glueless)
- suitable for rooms with normal humidity

Fire classification: Ds1d0



 A solution for door frame for MFC boards

 Rear-mounted beam

 Wall and partition mounting

 Optionally Support leg mounted frontally for 18 mm boards

 Optionally Support leg screwed into the core for 28 mm boards

HPL

High pressure laminate

10 mm

12 mm

HPL (High Pressure Laminate) - cellulose fibers saturated with resin and compressed under high pressure. The material is 100% waterproof and its properties are consistent throughout the entire board cross-section.

- milled edges-black core of the board is visible
- for rooms with high humidity

Fire classification: Cs1d0 - 10 mm, Bs1d0 - 12 mm (option)



 A solution for door frame for HPL boards

 Rear-mounted beam

 Wall and partition mounting

 Optionally Support leg mounted frontally

SP

Sandwich panels

36 mm

Panels with a total thickness of 36 mm - feature an aluminum frame filled with foamed polystyrene, 28 mm thick, with outer layers consisting of 4 mm HPL.

- excellent rigidity and aesthetics
- ideal for full-height installations
- provide the best soundproofing

Fire classification: Es1d0



 A solution for door frame for SP boards

 Rear-mounted beam

 Concealed mounting for walls and partitions

 Possibility of using a handle

 Optionally Support leg screwed into the core



URINAL PARTITIONS

By using an aluminum rosette, we achieved an effect of exceptional lightness.

ALSANIT urinal partitions are installed using rosettes, eliminating the need for support legs.

available
colors



page 14 →



Urinal partitions

- Powder-coated rosette in a color close to RAL 7035
- Easy installation
- Minimalist appearance

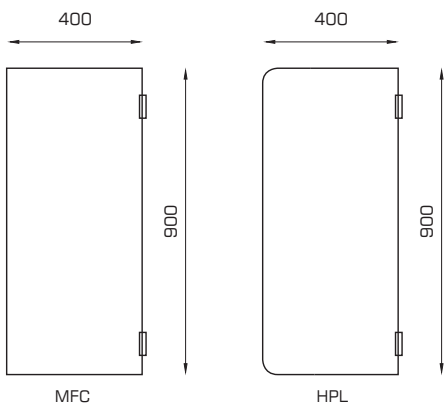

MFC

- 18 mm
- 28 mm

HPL

- 10 mm
- 12 mm

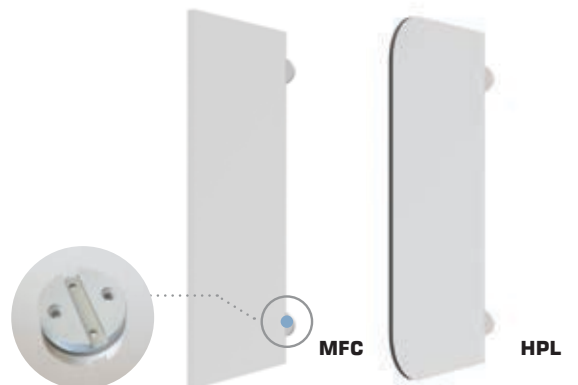



VANITY TOPS

Sink countertops are an important element of restroom furnishings.

Due to the direct exposure to water, they need to be made of durable materials and properly installed.

available
colors

page 14 →





Vanity tops

- preparation for sink installation
- all visible edges routed
- need for panel joining for countertops longer than 2600 mm
- optionally additional mirror frames matching countertops

HPL

- 10 mm
- 12 mm

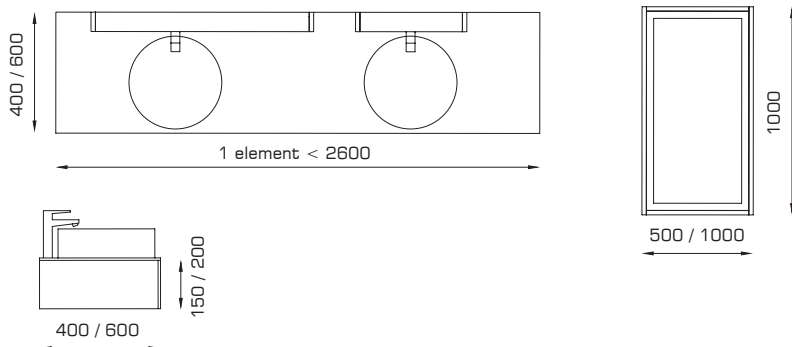



SHOWERS

Shower cubicles produced by ALSANIT are aesthetic, practical, and durable.

Thanks to the use of durable, and fully waterproof materials, ALSANIT shower cubicles are an investment for many years. Showers are typically made basing on the SOLARI system fittings.

available
colors



page 14 →

„I” partitions

- easy and fast installation
- curtain included

HPL

10 mm

12 mm

← back

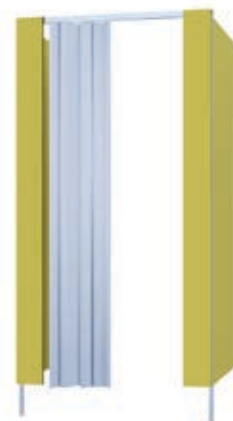
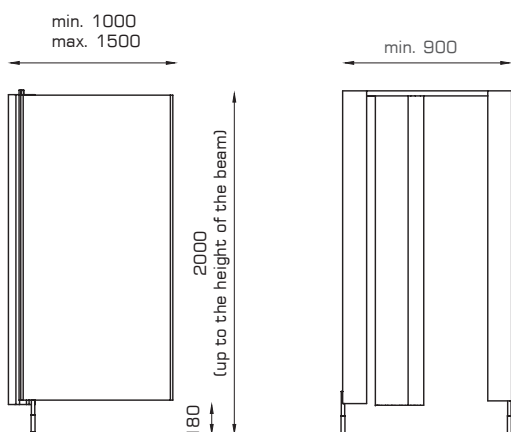

Showers „T” i „F”

- additional space for storing clothes
- curtain included

HPL

10 mm

12 mm

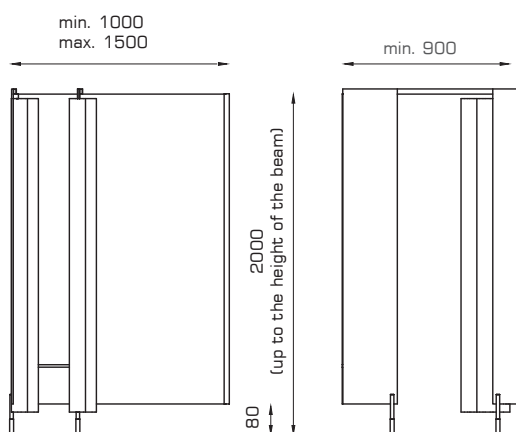

Showers with doors

- doors reinforced with ribs approximately 80 mm wide
- round profile for clothes or towel between the ribs

HPL

10 mm

12 mm

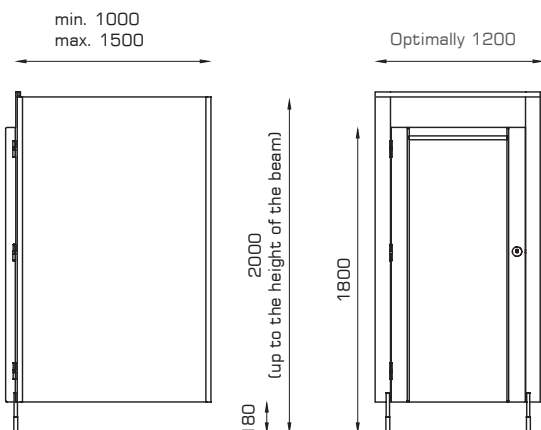



TECHNOWALL

Fast mounted and aesthetically pleasing wall claddings designed for large surfaces.

TECHNOWALL is a fully proprietary system of wall claddings with quick access to installations located behind them.

available
colors



page 14 →

HPL

- 10 mm
- 12 mm

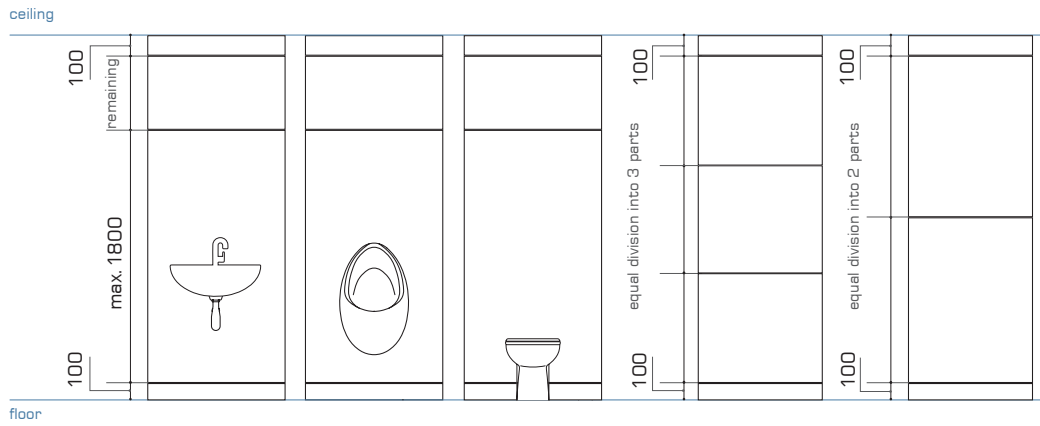

Installation:



1. Level and mount the bottom profile to the floor.

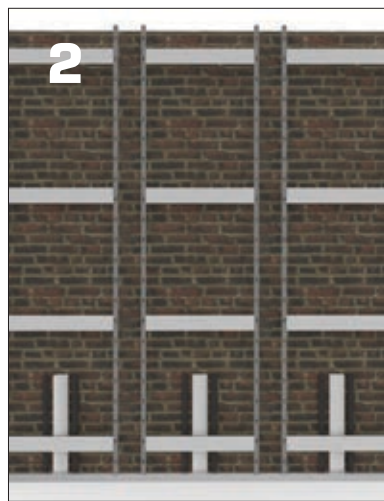

2. Place the steel frames for cladding on the profile, align, and attach them to the masonry wall.



3. Connect the frames with „shadow” panels. Mount masking panels at the bottom and top.



4. Fit the cladding panels up to the height of the utilities and fixtures. For the cladding where fixtures will be installed, cut openings for the connections/fixtures.

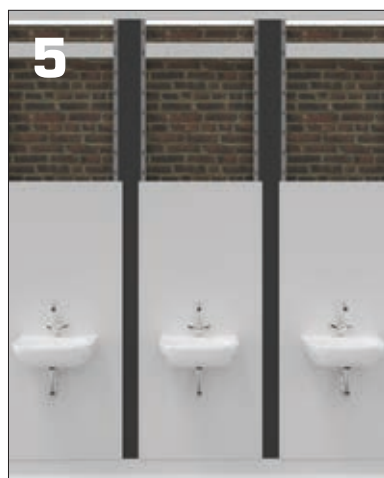

5. Secure and connect the fixtures to the cladding.



6. Install the remaining cladding.

COLORS stock collection

HPL







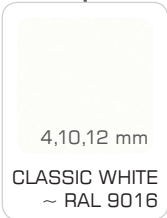
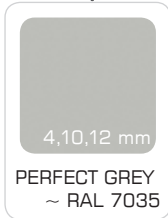
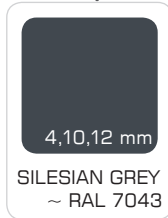

LOCKERS

HPL BUILT-INS

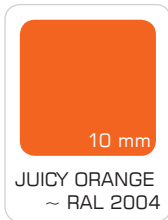
CUBICLES

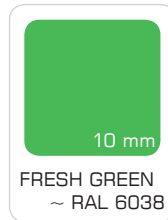
CONTRACT FURNITURE

standard colors of locker bodies
standard colors of Sandwich Panels

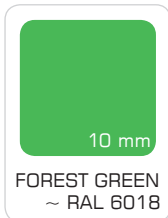
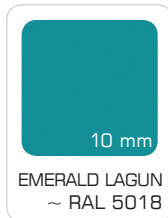
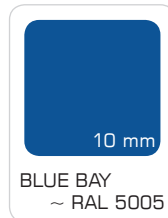
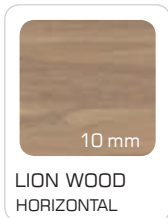
 4,10,12 mm CLASSIC WHITE ~ RAL 9016	 4,10,12 mm PERFECT GREY ~ RAL 7035	 4,10,12 mm SILESIA N GREY ~ RAL 7043			
 10 mm JUICY LEMON ~ RAL 1016	 10 mm JUICY ORANGE ~ RAL 2004	 10 mm RED DELUXE ~ RAL 3020	 10 mm FRESH GREEN ~ RAL 6038	 10,12 mm SHADOW GREY ~ RAL 7042	 10 mm CLASSIC BLACK ~ RAL 9005
 10 mm SPICE ORANGE ~ RAL 2008	 10 mm FOREST GREEN ~ RAL 6018	 10 mm EMERALD LAGUN ~ RAL 5018	 10 mm BLUE BAY ~ RAL 5005		 10 mm LION WOOD HORIZONTAL

colors available only for lockers and furniture

METAL

LOCKERS

standard colors of locker bodies

 PURE WHITE ~ RAL 9010	 PERFECT GREY ~ RAL 7035	 COAL GREY ~ RAL 7016			
 JUICY ORANGE ~ RAL 2004	 RED HOT ~ RAL 3000	 FOREST GREEN ~ RAL 6018	 OCEAN BLUE ~ RAL 5010	 MARINA BLUE ~ RAL 5015	 CLASSIC BLACK ~ RAL 9005

* sample colors

MFC

LOCKERS

CUBICLES

CONTRACT FURNITURE

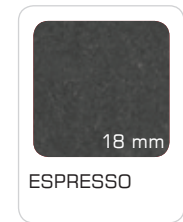
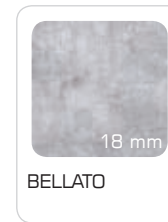
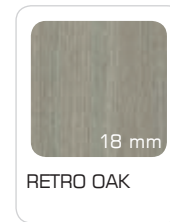
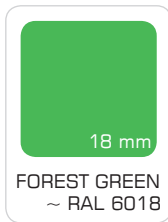
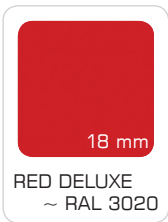
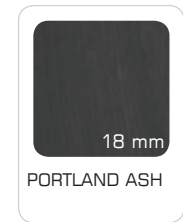
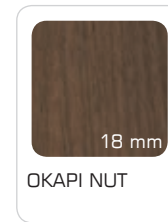
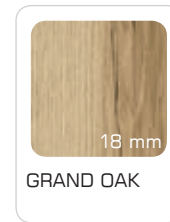
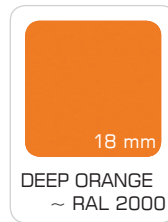
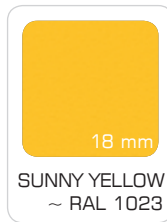
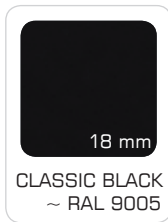
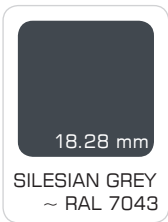
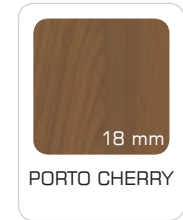
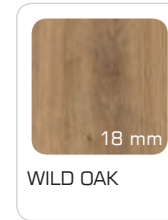
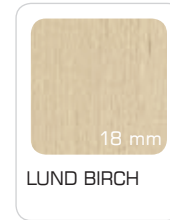
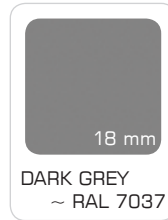
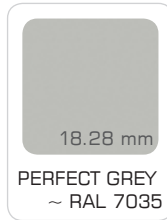
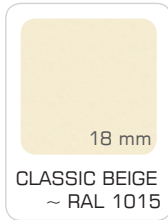
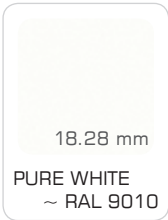

the color range is also available in the **HIGH GLOSS** version

GLASS

LOCKERS

CUBICLES

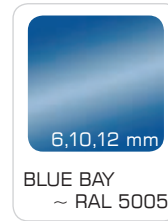
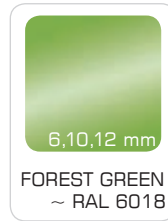
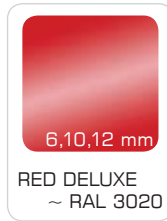
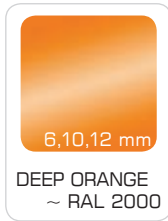
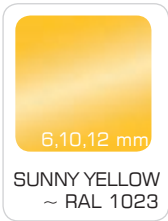
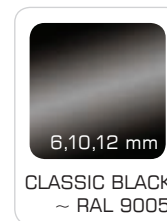
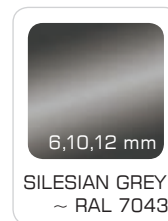
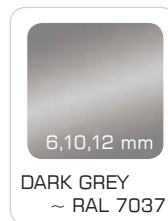
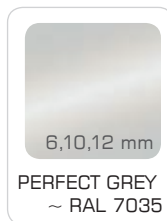
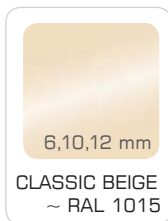
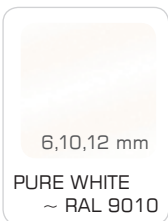

* sample colors

20+

20 years of experience

25+

sales to over 25 countries

2600+

2600 projects annually

8000+

sqm of ALSANIT's hall space

40000+

doors produced annually

ALTUS, full-height sanitary partitions that improve user comfort and the aesthetics of the room.

Optimally utilize available space, organizing it and improving its usability.



ALSANIT®

Alsanit Sp. z o.o.

ul. Wieleńska 2, 64-980 Trzcianka, POLSKA

+48 67 253 23 60

alsanit@alsanit.pl

www.alsanit.pl