



COMBO

COMBO



AC 171

COMBO modular, hpl / mfc / glass doors

Body:

METAL - powder-coated galvanized steel

Doors:

HPL - High pressure laminate

MFC - Laminated Chipboard

GLASS - Tempered glass

Description:

The COMBO lockers combine the best features of products available on the market. They have the lightness typical of metal bodies, while the doors, being the most exposed to wear, are made of durable materials.

The locker bodies are always made of galvanized steel, coated with powder paint. The doors use materials available in various decors and structures, allowing for the creation of unique designs.

Thanks to the patented modular construction, the possibilities for locker applications are practically limitless. The body can be customized even after delivery to the destination. Changes to the interior equipment, dimensions, opening direction, and even door material are possible.

Combining durability with elegance and competitive pricing - COMBO lockers are, in our opinion, the perfect choice.



page 15 →

 only Torx screws are used

 fully assembled product

 the possibility of custom built

 easy to clean



Patent
P.434877 (lockers)
Protected design
WP.30407 (hinge)



Quality confirmed by
certificates

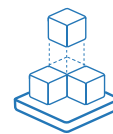

Flexibility for changes at
any time



Even gaps between the
doors



Certificate of conformity
number: PN-EN
16121+A1:2017-11



Frontlaying doors



Eco-design according to
the concept of REUSE

Standard dimensions

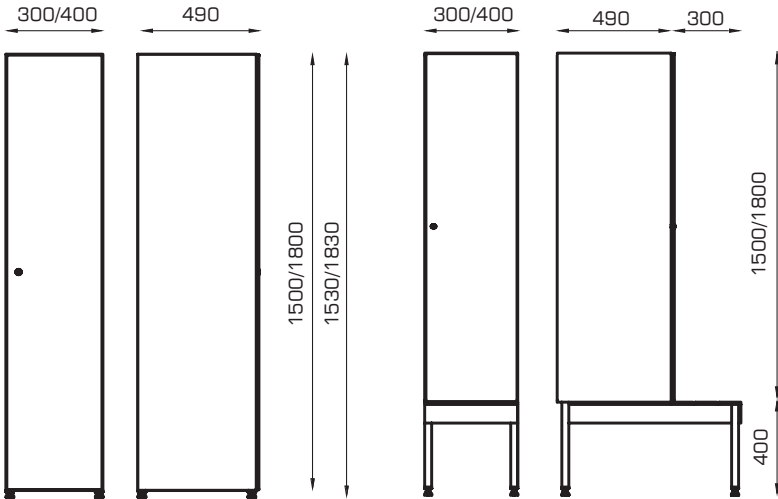

Base options

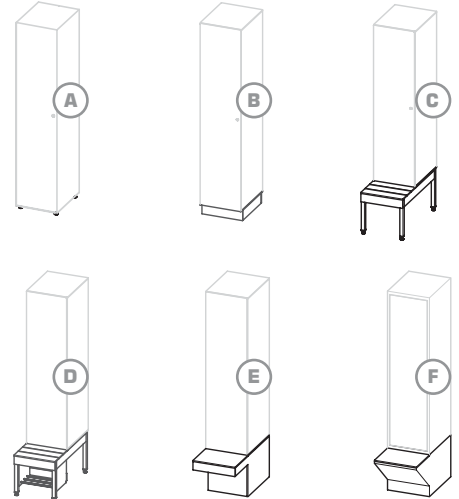

Standard equipment

patented hinge
manufactured by ALSANIT



stable, aluminum rod
and durable hooks
manufactured by ALSANIT



as a standard - key lock
or a padlock



the door in the selected variant:
HPL 10/12 mm, **MFC** 18 mm, **GLASS** 6 mm

the body and back made of galvanized steel:
0.7 mm powder-coated

adjustable leg

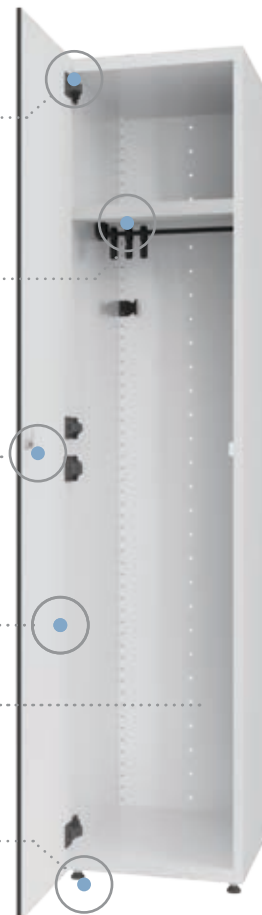

available additional
options

page 8 →

available lock
options

page 14 →

available
colors

page 16 →



Single-level lockers

Doors available in:

MFC HPL GLASS

STANDARD VERSION



300/400



600/800

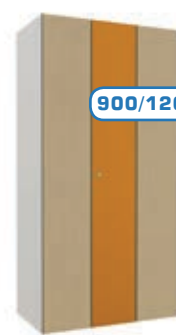

900/1200



1200/-

DIMENSIONS	PRODUCT CODE	CD-15311-01	CD-15411-01	CD-15321-01	CD-15421-01	CD-15331-01	CD-15431-01	CD-15341-01	-
	HEIGHT	1500	1500	1500	1500	1500	1500	1500	-
	PRODUCT CODE	CD-18311-01	CD-18411-01	CD-18321-01	CD-18421-01	CD-18331-01	CD-18431-01	CD-18341-01	-
	HEIGHT	1800	1800	1800	1800	1800	1800	1800	-
	OVERALL WIDTH	300	400	600	800	900	1200	1200	-
	COLUMN WIDTH	1X300	1X400	2X300	2X400	3X300	3X400	4X300	-
	DEPTH	490	490	490	490	490	490	490	-
EQUIPMENT	LEGS HEIGHT 30	✓	✓	✓	✓	✓	✓	✓	-
	SHELF	✓	✓	✓	✓	✓	✓	✓	-
	BAR WITH HOOKS	✓	✓	✓	✓	✓	✓	✓	-
	CLOTHING HOOK	✓	✓	✓	✓	✓	✓	✓	-
	KEY LOCK	✓	✓	✓	✓	✓	✓	✓	-
	PADLOCK LOCK	✓	✓	✓	✓	✓	✓	✓	-

+	TYPES OF LOCKS	AVAILABLE TYPES OF LOCKS: PAGE 14
	ADDITIONAL OPTIONS	AVAILABLE ADDITIONAL OPTIONS: PAGE 8
	COLOR OPTIONS	AVAILABLE COLOR OPTIONS: PAGE 16

COMBO

Two-level lockers

Doors available in:

MFC HPL GLASS

STANDARD VERSION



DIMENSIONS	PRODUCT CODE	CD-15312-01	CD-15412-01	CD-15322-01	CD-15422-01	CD-15332-01	CD-15432-01	CD-15342-01	-
	HEIGHT	1500	1500	1500	1500	1500	1500	1500	-
	PRODUCT CODE	CD-18312-01	CD-18412-01	CD-18322-01	CD-18422-01	CD-18332-01	CD-18432-01	CD-18342-01	-
	HEIGHT	1800	1800	1800	1800	1800	1800	1800	-
	OVERALL WIDTH	300	400	600	800	900	1200	1200	-
	COLUMN WIDTH	1X300	1X400	2X300	2X400	3X300	3X400	4X300	-
DEPTH	490	490	490	490	490	490	490	490	
EQUIPMENT	LEGS HEIGHT 30	✓	✓	✓	✓	✓	✓	✓	-
	SHELF	✓	✓	✓	✓	✓	✓	✓	-
	BAR WITH HOOKS	✓	✓	✓	✓	✓	✓	✓	-
	CLOTHING HOOK	✓	✓	✓	✓	✓	✓	✓	-
	KEY LOCK	✓	✓	✓	✓	✓	✓	✓	-
PADLOCK LOCK	✓	✓	✓	✓	✓	✓	✓	-	

+	TYPES OF LOCKS	AVAILABLE TYPES OF LOCKS: PAGE 14
	ADDITIONAL OPTIONS	AVAILABLE ADDITIONAL OPTIONS: PAGE 8
	COLOR OPTIONS	AVAILABLE COLOR OPTIONS: PAGE 16

COMBO

modular, hpl / mfc / glass doors

Three-level lockers

Doors available in:

MFC HPL GLASS



STANDARD VERSION

DIMENSIONS	PRODUCT CODE	CD-15313-00	CD-15413-00	CD-15323-00	CD-15423-00	CD-15333-00	CD-15433-00	CD-15343-00	-
	HEIGHT	1500	1500	1500	1500	1500	1500	1500	-
	PRODUCT CODE	CD-18313-00	CD-18413-00	CD-18323-00	CD-18423-00	CD-18333-00	CD-18433-00	CD-18343-00	-
	HEIGHT	1800	1800	1800	1800	1800	1800	1800	-
	OVERALL WIDTH	300	400	600	800	900	1200	1200	-
	COLUMN WIDTH	1X300	1X400	2X300	2X400	3X300	3X400	4X300	-
DEPTH	490	490	490	490	490	490	490	-	
EQUIPMENT	LEGS HEIGHT 30	✓	✓	✓	✓	✓	✓	✓	-
	SHELF	-	-	-	-	-	-	-	-
	BAR WITH HOOKS	-	-	-	-	-	-	-	-
	CLOTHING HOOK	✓	✓	✓	✓	✓	✓	✓	-
	KEY LOCK	✓	✓	✓	✓	✓	✓	✓	-
	PADLOCK LOCK	✓	✓	✓	✓	✓	✓	✓	-

+	TYPES OF LOCKS	AVAILABLE TYPES OF LOCKS: PAGE 14
	ADDITIONAL OPTIONS	AVAILABLE ADDITIONAL OPTIONS: PAGE 8
	COLOR OPTIONS	AVAILABLE COLOR OPTIONS: PAGE 16

Five-level lockers

Doors available in:

MFC HPL GLASS



STANDARD VERSION

DIMENSIONS	PRODUCT CODE	CD-15315-00	CD-15415-00	CD-15325-00	CD-15425-00	CD-15335-00	CD-15435-00	CD-15345-00	-
	HEIGHT	1500	1500	1500	1500	1500	1500	1500	-
	PRODUCT CODE	CD-18315-00	CD-18415-00	CD-18325-00	CD-18425-00	CD-18335-00	CD-18435-00	CD-18345-00	-
	HEIGHT	1800	1800	1800	1800	1800	1800	1800	-
	OVERALL WIDTH	300	400	600	800	900	1200	1200	-
	COLUMN WIDTH	1X300	1X400	2X300	2X400	3X300	3X400	4X300	-
DEPTH	490	490	490	490	490	490	490	-	
EQUIPMENT	LEGS HEIGHT 30	✓	✓	✓	✓	✓	✓	✓	-
	SHELF	-	-	-	-	-	-	-	-
	BAR WITH HOOKS	-	-	-	-	-	-	-	-
	CLOTHING HOOK	-	-	-	-	-	-	-	-
	KEY LOCK	✓	✓	✓	✓	✓	✓	✓	-
	PADLOCK LOCK	✓	✓	✓	✓	✓	✓	✓	-

+	TYPES OF LOCKS	AVAILABLE TYPES OF LOCKS: PAGE 14
	ADDITIONAL OPTIONS	AVAILABLE ADDITIONAL OPTIONS: PAGE 8
	COLOR OPTIONS	AVAILABLE COLOR OPTIONS: PAGE 16

Four-level lockers

Doors available in:

MFC HPL GLASS

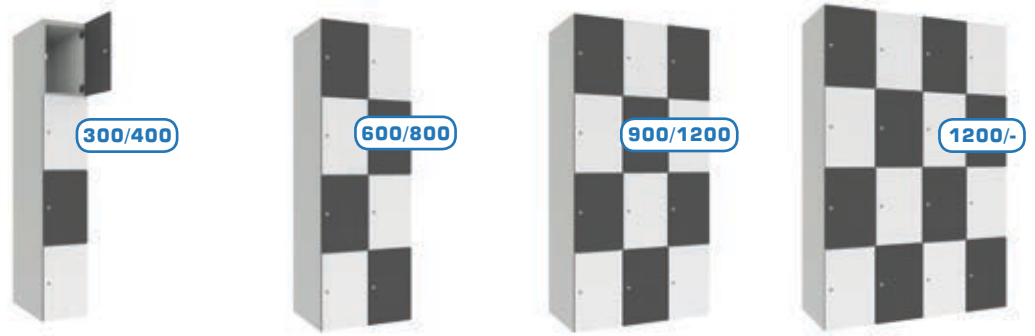

STANDARD VERSION

DIMENSIONS	PRODUCT CODE	CD-15314-00	CD-15414-00	CD-15324-00	CD-15424-00	CD-15334-00	CD-15434-00	CD-15344-00	-
	HEIGHT	1500	1500	1500	1500	1500	1500	1500	-
	PRODUCT CODE	CD-18314-00	CD-18414-00	CD-18324-00	CD-18424-00	CD-18334-00	CD-18434-00	CD-18344-00	-
	HEIGHT	1800	1800	1800	1800	1800	1800	1800	-
	OVERALL WIDTH	300	400	600	800	900	1200	1200	-
	COLUMN WIDTH	1X300	1X400	2X300	2X400	3X300	3X400	4X300	-
DEPTH	490	490	490	490	490	490	490	-	
EQUIPMENT	LEGS HEIGHT 30	✓	✓	✓	✓	✓	✓	✓	-
	SHELF	-	-	-	-	-	-	-	-
	BAR WITH HOOKS	-	-	-	-	-	-	-	-
	CLOTHING HOOK	-	-	-	-	-	-	-	-
	KEY LOCK	✓	✓	✓	✓	✓	✓	✓	-
	PADLOCK LOCK	✓	✓	✓	✓	✓	✓	✓	-
+	TYPES OF LOCKS	AVAILABLE TYPES OF LOCKS: PAGE 14							
	ADDITIONAL OPTIONS	AVAILABLE ADDITIONAL OPTIONS: PAGE 8							
	COLOR OPTIONS	AVAILABLE COLOR OPTIONS: PAGE 16							

Clothing lockers L

Doors available in:

HPL GLASS



STANDARD VERSION

DIMENSIONS	PRODUCT CODE	CZ-15312-00	CZ-15412-00	CZ-15322-00	CZ-15422-00	CZ-15332-00	CZ-15432-00	CZ-15342-00	-
	HEIGHT	1500	1500	1500	1500	1500	1500	1500	-
	PRODUCT CODE	CZ-18312-00	CZ-18412-00	CZ-18322-00	CZ-18422-00	CZ-18332-00	CZ-18432-00	CZ-18342-00	-
	HEIGHT	1800	1800	1800	1800	1800	1800	1800	-
	OVERALL WIDTH	300	400	600	800	900	1200	1200	-
	COLUMN WIDTH	1X300	1X400	2X300	2X400	3X300	3X400	4X300	-
DEPTH	490	490	490	490	490	490	490	-	
EQUIPMENT	LEGS HEIGHT 30	✓	✓	✓	✓	✓	✓	✓	-
	SHELF	-	-	-	-	-	-	-	-
	BAR WITH HOOKS	✓	✓	✓	✓	✓	✓	✓	-
	CLOTHING HOOK	✓	✓	✓	✓	✓	✓	✓	-
	KEY LOCK	✓	✓	✓	✓	✓	✓	✓	-
	PADLOCK LOCK	✓	✓	✓	✓	✓	✓	✓	-
+	TYPES OF LOCKS	AVAILABLE TYPES OF LOCKS: PAGE 14							
	ADDITIONAL OPTIONS	AVAILABLE ADDITIONAL OPTIONS: PAGE 8							
	COLOR OPTIONS	AVAILABLE COLOR OPTIONS: PAGE 16							

Additional options



AVAILABLE FOR LOCKERS MADE OF:

	HPL	METAL	MFC
PLATE 30X30	✓	✓	✓
PLATE 35X60	✓	✓	✓
PLATE 45X120	✓	✓	✓
ENGRAVING	✓	-	-
BAR WITH HOOKS	✓	✓	✓
ANTI-BURGLARY SYSTEM	✓	-	✓

POSSIBILITY OF MAKING FROM:

	HPL	METAL	MFC
CUSTOM DIVISION	✓	✓	✓
SLANTED ROOF	✓	✓	-
PLINTH	✓	✓	✓
LEG COVERS	✓	-	✓



Connecting lockers into wardrobes

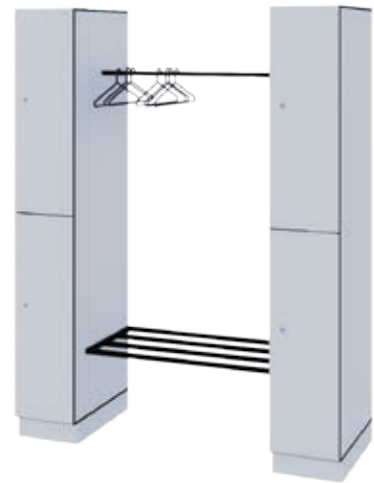
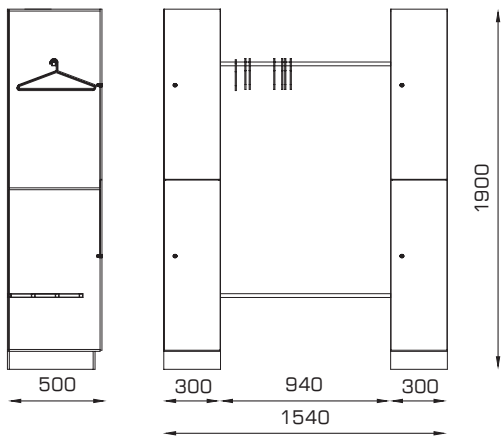

Side and corner covers

HPL / MFC / METAL

MIRROR

HPL / MFC / METAL

VANITY - functional and compact

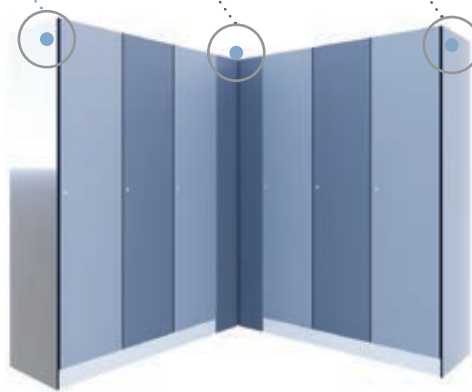



BENCHES

Benches are the perfect add on to any locker room.

Properly chosen, they can add character to the interior - make it more friendly and inviting.

available
colors



page 16 →

Benches PRO-FI

HPL

← back

10 mm

12 mm

Classic approach

Aluminum construction with seats made of HPL.
Standard ALSANIT benches.

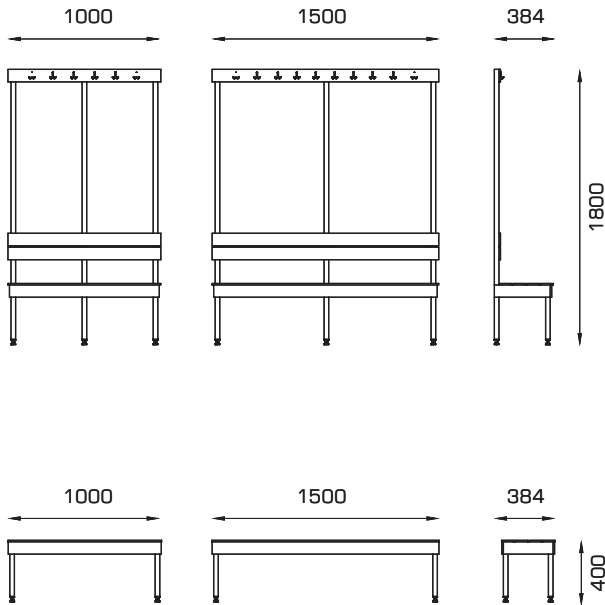

Benches LO-FI

HPL

10 mm

12 mm

Metal bench with an eye-catching seat

An elegant combination of steel and wood-like HPL panels.
Optionally include hooks.

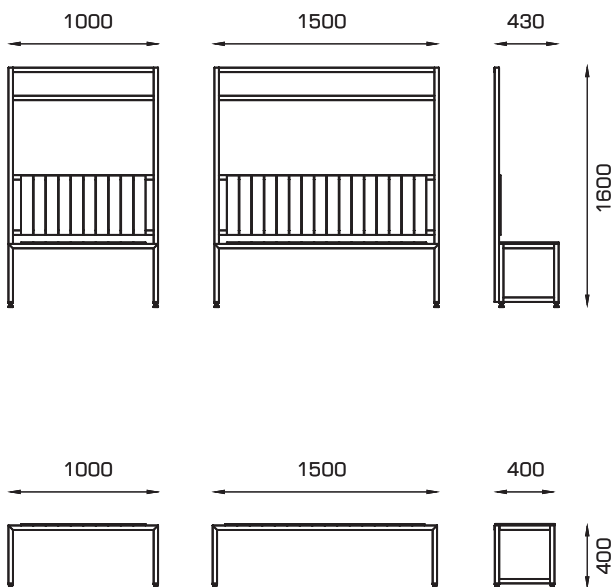

Benches HI-FI

HPL

10 mm

12 mm

Openwork backs

Steel frames with HPL seats.

Optionally include hooks.

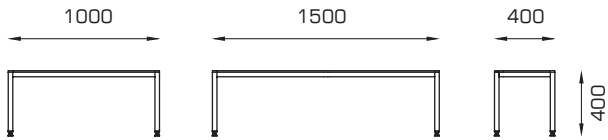
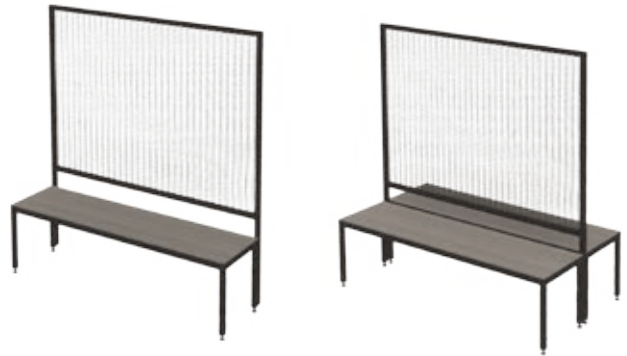
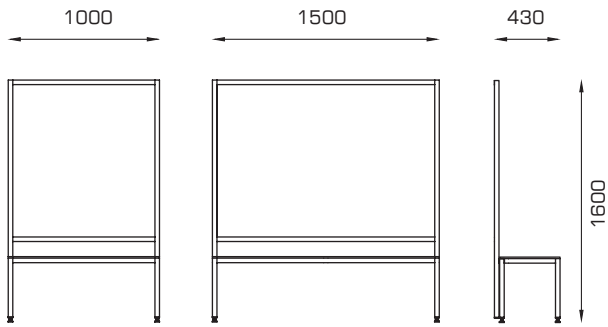

Options - available for any model

Option with low backrest

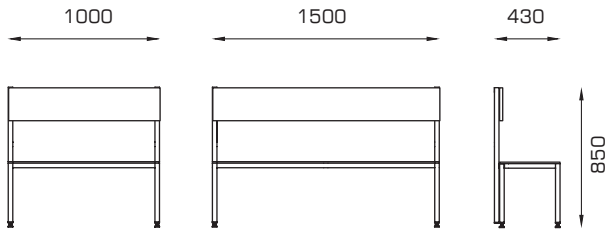

Optional slat direction for seats

Optional shoe shelf



Upholstered benches

← back

Elegance and comfort

The combination of a classic bench with elegant upholstery
- beauty and elegance encapsulated in a simple minimalist
form. Perfect for both modern and classical interiors.

IRIS

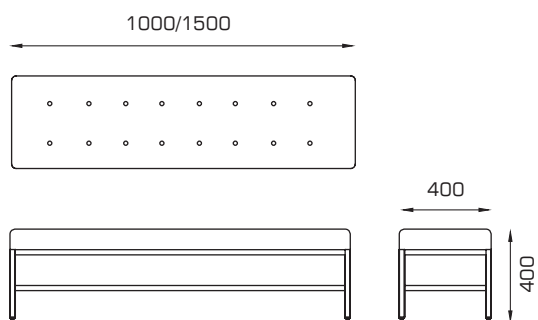

LANDO

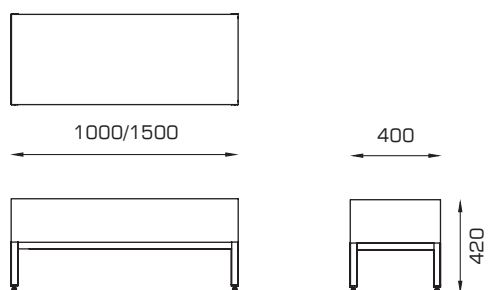

Locks for lockers

Security - a common value of the locks we offer, that is why we only provide those from reputable manufacturers. Below, we describe three additional features that guided us in selecting the locks for our products.

Waterproofnes - prepared to work in any conditions.

Prioritizing quality above all, we have decided that all locks offered by us are suitable for use in moist areas.

Interchangeability - lock models can be exchanged at any time, changing from a lower model to a higher one. This way, the locker room can be modernized without the need for costly door replacement. When changing locks to deposit or electronic locks, additional holes will have to be made in doors.

Availability - don't waste time waiting.

A strong aspect of our offer is the availability of locks on stock, significantly reducing the time needed to complete the order. For projects with slot or digital locks above 200 compartments, please contact us to confirm availability.

Cam locks, the locks we offer have a 1/1000 combination, meaning the chance of opening with your key any another locker is 0.1%.



Padlock locks, an alternative to key locks is padlocks. The recommended shackle diameter for padlocks is 5-7 mm.



The option to use any lock.

We are not limited to our own selection; we can integrate the locker with any lock specified by the client.

Code locks are maintenance-free solutions. All code locks offered by us have a master key opening option in case the code is forgotten.



Deposit locks, Coin-operated or token-operated locks are capable of accepting coins or tokens into a special container. Locks can operate on coins of 1/2 EUR. In case of key loss, locks can be opened using a master key.



Electronic lock that support the standard RFID are modern programmable locks operated by CARDS, WRISTBANDS, or other RFID TOKENS. Available in both OFFLINE versions powered by batteries and ONLINE versions powered externally.





033

043

034



LOXER transforms lockers into solutions

ALSANIT introduces innovative solutions in the field of lockers with smart locks, enabling electronic control over them.

Thanks to cooperation with the renowned brand LOXER, representing the most advanced intelligent locking system available on the market, we can confidently offer this solution to our customers.

LOXER stands out not only for its ease of use but also for its rich configuration options, ensuring easy management and convenient use.



The possibility of integration for any ALSANIT locker system



Full service including installation and training



The ability to integrate with the client's database



The ability to customize the software to individual needs

LOXER is an intelligent locker system that introduces a new era of facility management.

Examples of applications by industry

INDUSTRIES

	OFFICES	SCHOOLS	STORES	PHARMACY	FACTORIES	SPORTS FACILITIES	LOGISTICS SHIPMENTS	HEALTHCARE	PUBLIC AREAS	GASTRONOMY
FUNCTIONS										
STORAGE	✓	✓				✓		✓	✓	✓
DISPENSE	✓	✓	✓	✓	✓	✓	✓	✓		
DROP OFF / PICK UP	✓	✓	✓		✓		✓		✓	
CLOAKROOM	✓	✓	✓		✓	✓	✓	✓	✓	✓

- Receive all your parcels from any carrier in one place.
- Effortlessly dispense workwear or distribute mail.
- Exchange documents or keys using easily managed lockers.
- Reduce costs by flexibly assigning users to lockers in the changing room.
- Control the circulation of tools or electronic equipment.
- Earn money by selling oversized items in hospitals, sports facilities, etc.

COLORS stock collection

HPL

LOCKERS

HPL BUILT-INS

CUBICLES

CONTRACT FURNITURE

standard colors of locker bodies

standard colors of Sandwich Panels

<p>4,10,12 mm</p> <p>CLASSIC WHITE ~ RAL 9016</p>	<p>4,10,12 mm</p> <p>PERFECT GREY ~ RAL 7035</p>	<p>4,10,12 mm</p> <p>SILESIA GREY ~ RAL 7043</p>				
<p>10 mm</p> <p>JUICY LEMON ~ RAL 1016</p>	<p>10 mm</p> <p>JUICY ORANGE ~ RAL 2004</p>	<p>10 mm</p> <p>RED DELUXE ~ RAL 3020</p>	<p>10 mm</p> <p>FRESH GREEN ~ RAL 6038</p>		<p>10,12 mm</p> <p>SHADOW GREY ~ RAL 7042</p>	<p>10 mm</p> <p>CLASSIC BLACK ~ RAL 9005</p>
<p>10 mm</p> <p>SPICE ORANGE ~ RAL 2008</p>	<p>10 mm</p> <p>FOREST GREEN ~ RAL 6018</p>	<p>10 mm</p> <p>EMERALD LAGUN ~ RAL 5018</p>	<p>10 mm</p> <p>BLUE BAY ~ RAL 5005</p>			<p>10 mm</p> <p>LION WOOD HORIZONTAL</p>

colors available only for lockers and furniture

METAL

LOCKERS

standard colors of locker bodies

<p>PURE WHITE ~ RAL 9010</p>	<p>PERFECT GREY ~ RAL 7035</p>	<p>COAL GREY ~ RAL 7016</p>			
<p>JUICY ORANGE ~ RAL 2004</p>	<p>RED HOT ~ RAL 3000</p>	<p>FOREST GREEN ~ RAL 6018</p>	<p>OCEAN BLUE ~ RAL 5010</p>	<p>MARINA BLUE ~ RAL 5015</p>	<p>CLASSIC BLACK ~ RAL 9005</p>

* sample colors

MFC

LOCKERS

CUBICLES

CONTRACT FURNITURE



the color range is also available in the **HIGH GLOSS** version

GLASS

LOCKERS

CUBICLES



* sample colors



ALSANIT®

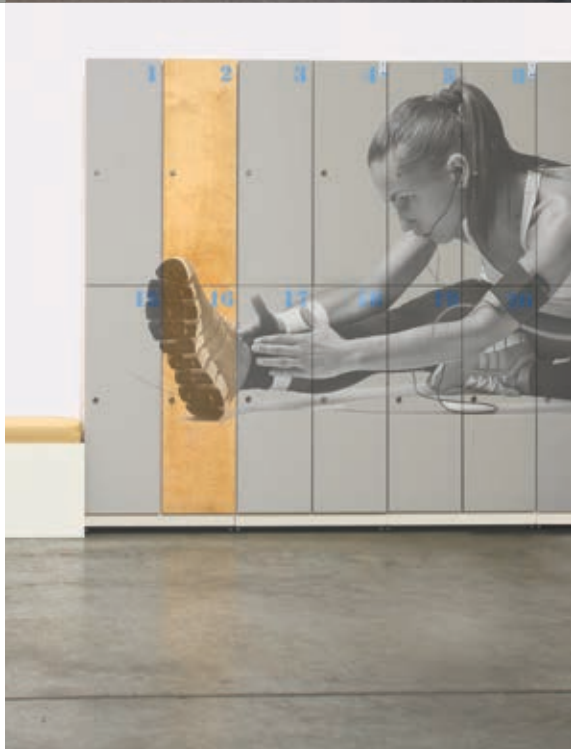



The **STOCK** version - at no extra cost

Take advantage of our extensive stock collection of available HPL, MFC, and GLASS, as well as metal paint, and configure furniture at no extra cost. There are countless configuration possibilities.



The **EXTENDED** Version - extra charge

If you would like to have the furniture bodies made in colors other than those originally designated for bodies, there is an additional surcharge of +15%.



BESPOKE Version - custom color scheme upon individual request

In addition to non-standard board colors, we can also enrich the project with graphics or decals. If you wish for colors not available in our warehouse collection, you can choose any board color, paint, or decor from the available palette, and we will order it for you.

HPL + MFC - available from the ALSANIT board suppliers' collections
PAINT FOR METAL + GLASS - available from the RAL color collection



20+

20 years of experience

25+

sales to over 25 countries

2600+

2600 projects annually

8000+

sqm of ALSANIT's hall space

40000+

doors produced annually

Our patented modular locker system is one of the best in the world.

The COMBO lockers are the result of years of experience and creativity. They retain the lightweight metal body while the modular design significantly enhances their durability and allows for flexibility in terms of shape and color.



ALSANIT®

Alsanit Sp. z o.o.

ul. Wieleńska 2, 64-980 Trzcianka, POLSKA

+48 67 253 23 60

alsanit@alsanit.pl

www.alsanit.pl