



ALSANIT®

LUXA

**LUXA**



# LUXA MFC lockers

## Body:

**MFC** - Laminated chipboard

## Doors:

**MFC** - Laminated chipboard

## Description:

Lockers made of chipboard are highly regarded and versatile in their application - from modern offices to fitness clubs.

In the LUXA series, the available color palette of chipboard panels is impressive, and moreover, they are available in natural textures and patterns such as stone or wood. We do not limit ourselves only to doors; the bodies can also be made according to individual preferences, based on a wide range of panel decors.

An additional accent is provided by the

edges bonded with ABS tape using the latest hot-air edge banding technology, giving the effect of an almost invisible joint. This innovative technology is a standard for us, although it appeared on the market only a few years ago.







For facilities where furniture is not exposed to excessive moisture, LUXA lockers are an excellent choice because they offer the possibility of creating original and stylish compositions at an attractive price.

 Prepared for **Smart Locker**

page 15 →



Protected design:  
WP.30407 (hinge)

-  only Torx screws are used
-  fully assembled product
-  the possibility of custom built
-  smooth inner walls
-  custom sizing available
-  easy to clean



**Quality confirmed by certificates**



**Budget solutions**



**Even gaps between the doors**



**Frontlaying doors**

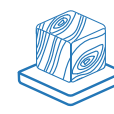

**Decors also available in 3D structure**



**Available in High Gloss**

### Standard dimensions

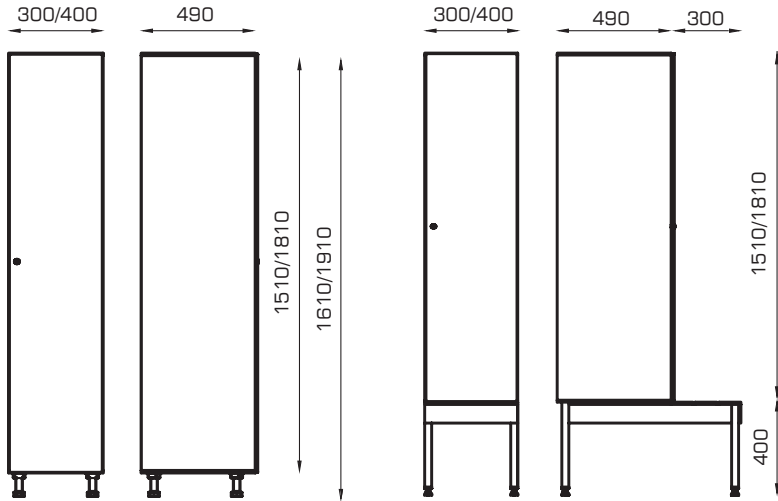

### Base options

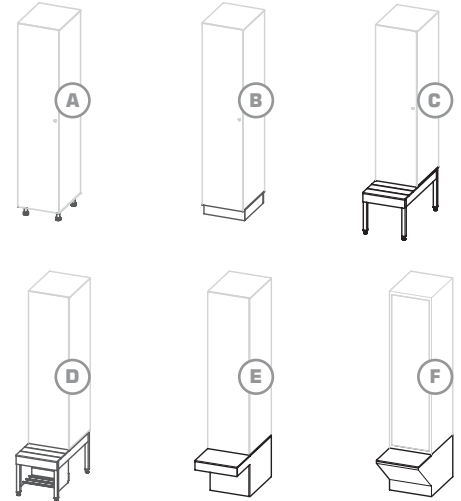

### Standard equipment



patented hinge .....  
manufactured by ALSANIT

stable, aluminum rod .....  
and durable hooks  
manufactured by ALSANIT

as a standard - key lock .....  
or a padlock

doors, body, back: **MFC** 18 mm

polyamide leg

available additional  
options

page 8 →

available lock  
options

page 14 →

available  
colors

page 18 →



# LUXA MFC lockers



## Single-level lockers



### STANDARD VERSION

DIMENSIONS	PRODUCT CODE	LD-15311-01	LD-15411-01	LD-15321-01	LD-15421-01	LD-15331-01	LD-15431-01	LD-15341-01	-
	HEIGHT	1510	1510	1510	1510	1510	1510	1510	-
EQUIPMENT	PRODUCT CODE	LD-18311-01	LD-18411-01	LD-18321-01	LD-18421-01	LD-18331-01	LD-18431-01	LD-18341-01	-
	HEIGHT	1810	1810	1810	1810	1810	1810	1810	-
	OVERALL WIDTH	300	400	600	800	900	1200	1200	-
	COLUMN WIDTH	1X300	1X400	2X300	2X400	3X300	3X400	4X300	-
	DEPTH	490	490	490	490	490	490	490	-
+	LEGS HEIGHT 100	✓	✓	✓	✓	✓	✓	✓	-
	SHELF	✓	✓	✓	✓	✓	✓	✓	-
	BAR WITH HOOKS	✓	✓	✓	✓	✓	✓	✓	-
	CLOTHING HOOK	✓	✓	✓	✓	✓	✓	✓	-
	KEY LOCK	✓	✓	✓	✓	✓	✓	✓	-
PADLOCK LOCK	✓	✓	✓	✓	✓	✓	✓	-	

### TYPES OF LOCKS

AVAILABLE TYPES OF LOCKS: PAGE 14

### ADDITIONAL OPTIONS

AVAILABLE ADDITIONAL OPTIONS: PAGE 8

### COLOR OPTIONS

AVAILABLE COLOR OPTIONS: PAGE 18



← back

## Two-level lockers



### STANDARD VERSION

DIMENSIONS	PRODUCT CODE	LD-15312-01	LD-15412-01	LD-15322-01	LD-15422-01	LD-15332-01	LD-15432-01	LD-15342-01	-
	HEIGHT	1510	1510	1510	1510	1510	1510	1510	-
	PRODUCT CODE	LD-18312-01	LD-18412-01	LD-18322-01	LD-18422-01	LD-18332-01	LD-18432-01	LD-18342-01	-
	HEIGHT	1810	1810	1810	1810	1810	1810	1810	-
	OVERALL WIDTH	300	400	600	800	900	1200	1200	-
	COLUMN WIDTH	1X300	1X400	2X300	2X400	3X300	3X400	4X300	-
	DEPTH	490	490	490	490	490	490	490	-
EQUIPMENT	LEGS HEIGHT 100	✓	✓	✓	✓	✓	✓	✓	-
	SHELF	✓	✓	✓	✓	✓	✓	✓	-
	BAR WITH HOOKS	✓	✓	✓	✓	✓	✓	✓	-
	CLOTHING HOOK	✓	✓	✓	✓	✓	✓	✓	-
	KEY LOCK	✓	✓	✓	✓	✓	✓	✓	-
	PADLOCK LOCK	✓	✓	✓	✓	✓	✓	✓	-

+	TYPES OF LOCKS	AVAILABLE TYPES OF LOCKS: PAGE 14
	ADDITIONAL OPTIONS	AVAILABLE ADDITIONAL OPTIONS: PAGE 8
	COLOR OPTIONS	AVAILABLE COLOR OPTIONS: PAGE 18

# LUXA MFC lockers

## Three-level lockers

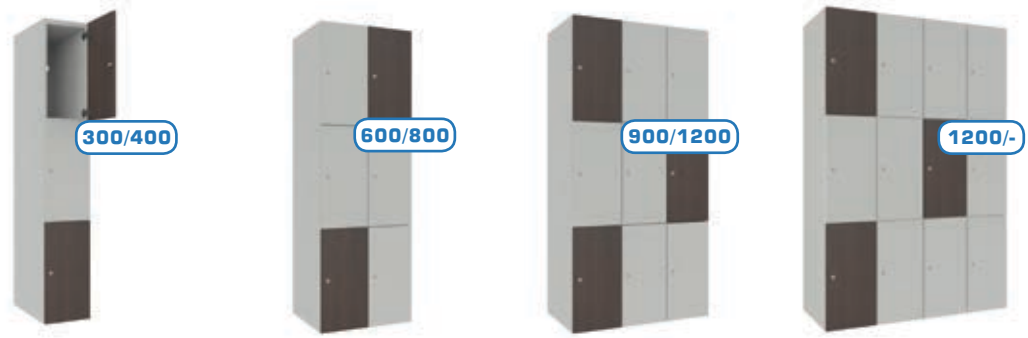

STANDARD VERSION

DIMENSIONS	PRODUCT CODE	LD-15313-00	LD-15413-00	LD-15323-00	LD-15423-00	LD-15333-00	LD-15433-00	LD-15343-00	-
	HEIGHT	1510	1510	1510	1510	1510	1510	1510	-
	PRODUCT CODE	LD-18313-00	LD-18413-00	LD-18323-00	LD-18423-00	LD-18333-00	LD-18433-00	LD-18343-00	-
	HEIGHT	1810	1810	1810	1810	1810	1810	1810	-
	OVERALL WIDTH	300	400	600	800	900	1200	1200	-
	COLUMN WIDTH	1X300	1X400	2X300	2X400	3X300	3X400	4X300	-
DEPTH	490	490	490	490	490	490	490	-	
EQUIPMENT	LEGS HEIGHT 100	✓	✓	✓	✓	✓	✓	✓	-
	SHELF	-	-	-	-	-	-	-	-
	BAR WITH HOOKS	-	-	-	-	-	-	-	-
	CLOTHING HOOK	✓	✓	✓	✓	✓	✓	✓	-
	KEY LOCK	✓	✓	✓	✓	✓	✓	✓	-
PADLOCK LOCK	✓	✓	✓	✓	✓	✓	✓	-	
+	TYPES OF LOCKS	AVAILABLE TYPES OF LOCKS: PAGE 14							
	ADDITIONAL OPTIONS	AVAILABLE ADDITIONAL OPTIONS: PAGE 8							
	COLOR OPTIONS	AVAILABLE COLOR OPTIONS: PAGE 18							

## Five-level lockers

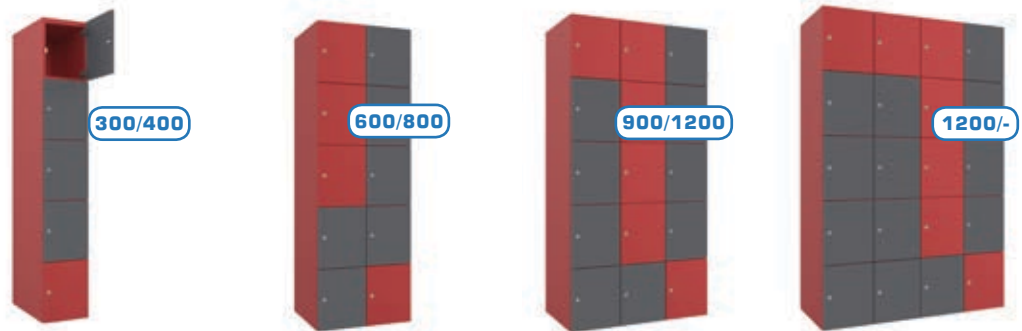

STANDARD VERSION

DIMENSIONS	PRODUCT CODE	LD-15315-00	LD-15415-00	LD-15325-00	LD-15425-00	LD-15335-00	LD-15435-00	LD-15345-00	-
	HEIGHT	1510	1510	1510	1510	1510	1510	1510	-
	PRODUCT CODE	LD-18315-00	LD-18415-00	LD-18325-00	LD-18425-00	LD-18335-00	LD-18435-00	LD-18345-00	-
	HEIGHT	1810	1810	1810	1810	1810	1810	1810	-
	OVERALL WIDTH	300	400	600	800	900	1200	1200	-
	COLUMN WIDTH	1X300	1X400	2X300	2X400	3X300	3X400	4X300	-
DEPTH	490	490	490	490	490	490	490	-	
EQUIPMENT	LEGS HEIGHT 100	✓	✓	✓	✓	✓	✓	✓	-
	SHELF	-	-	-	-	-	-	-	-
	BAR WITH HOOKS	-	-	-	-	-	-	-	-
	CLOTHING HOOK	-	-	-	-	-	-	-	-
	KEY LOCK	✓	✓	✓	✓	✓	✓	✓	-
PADLOCK LOCK	✓	✓	✓	✓	✓	✓	✓	-	
+	TYPES OF LOCKS	AVAILABLE TYPES OF LOCKS: PAGE 14							
	ADDITIONAL OPTIONS	AVAILABLE ADDITIONAL OPTIONS: PAGE 8							
	COLOR OPTIONS	AVAILABLE COLOR OPTIONS: PAGE 18							

## Four-level lockers



### STANDARD VERSION

DIMENSIONS	PRODUCT CODE	LD-15314-00	LD-15414-00	LD-15324-00	LD-15424-00	LD-15334-00	LD-15434-00	LD-15344-00	-
	HEIGHT	1510	1510	1510	1510	1510	1510	1510	-
	PRODUCT CODE	LD-18314-00	LD-18414-00	LD-18324-00	LD-18424-00	LD-18334-00	LD-18434-00	LD-18344-00	-
	HEIGHT	1810	1810	1810	1810	1810	1810	1810	-
	OVERALL WIDTH	300	400	600	800	900	1200	1200	-
	COLUMN WIDTH	1X300	1X400	2X300	2X400	3X300	3X400	4X300	-
DEPTH	490	490	490	490	490	490	490	-	
EQUIPMENT	LEGS HEIGHT 100	✓	✓	✓	✓	✓	✓	✓	-
	SHELF	-	-	-	-	-	-	-	-
	BAR WITH HOOKS	-	-	-	-	-	-	-	-
	CLOTHING HOOK	-	-	-	-	-	-	-	-
	KEY LOCK	✓	✓	✓	✓	✓	✓	✓	-
PADLOCK LOCK	✓	✓	✓	✓	✓	✓	✓	-	
+	TYPES OF LOCKS	AVAILABLE TYPES OF LOCKS: PAGE 14							
	ADDITIONAL OPTIONS	AVAILABLE ADDITIONAL OPTIONS: PAGE 8							
	COLOR OPTIONS	AVAILABLE COLOR OPTIONS: PAGE 18							



# Additional options



## AVAILABLE FOR LOCKERS MADE OF:

	HPL	METAL	MFC
<b>PLATE 30X30</b>	✓	✓	✓
<b>PLATE 35X60</b>	✓	✓	✓
<b>PLATE 45X120</b>	✓	✓	✓
<b>ENGRAVING</b>	✓	-	-
<b>BAR WITH HOOKS</b>	✓	✓	✓
<b>ANTI-BURGLARY SYSTEM</b>	✓	-	✓

## POSSIBILITY OF MAKING FROM:

	HPL	METAL	MFC
<b>CUSTOM DIVISION</b>	✓	✓	✓
<b>SLANTED ROOF</b>	✓	✓	-
<b>PLINTH</b>	✓	✓	✓
<b>LEG COVERS</b>	✓	-	✓





**Connecting lockers into wardrobes**

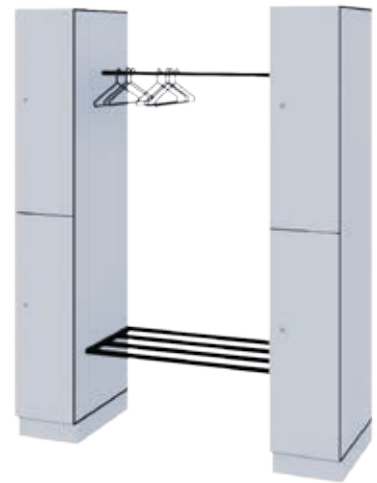
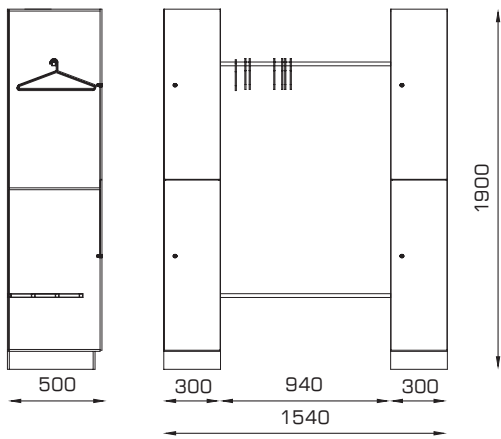

**Side and corner covers**

**HPL / MFC / METAL**

**MIRROR**

**HPL / MFC / METAL**

**VANITY - functional and compact**

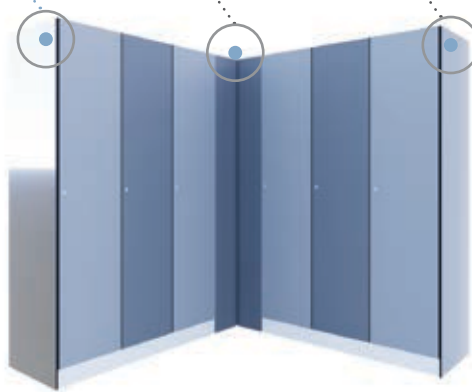



# BENCHES

**Benches are the perfect add on to any locker room.**

Properly chosen, they can add character to the interior - make it more friendly and inviting.

available  
colors



page 18 →

## Benches PRO-FI

HPL

← back

10 mm

12 mm

### Classic approach

Aluminum construction with seats made of HPL.  
Standard ALSANIT benches.

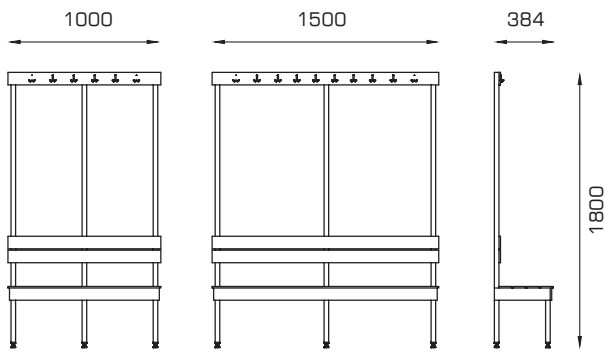

## Benches LO-FI

HPL

10 mm

12 mm

### Metal bench with an eye-catching seat

An elegant combination of steel and wood-like HPL panels.  
Optionally include hooks.

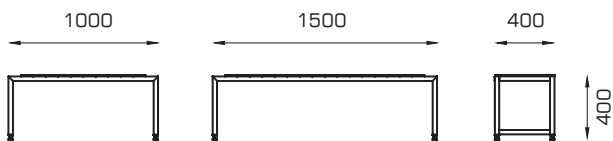
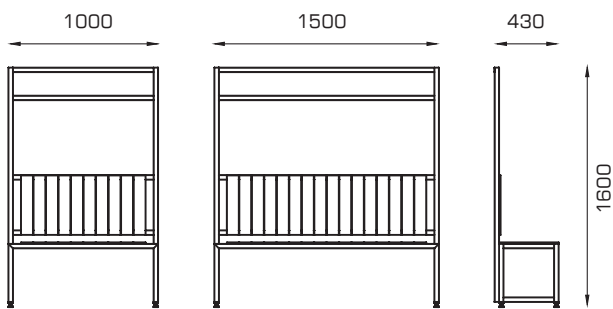

## Benches HI-FI

HPL

10 mm

12 mm

### Openwork backs

Steel frames with HPL seats.

Optionally include hooks.

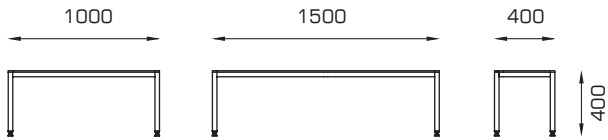
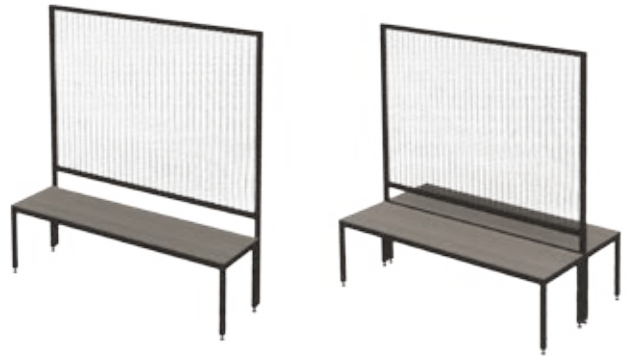
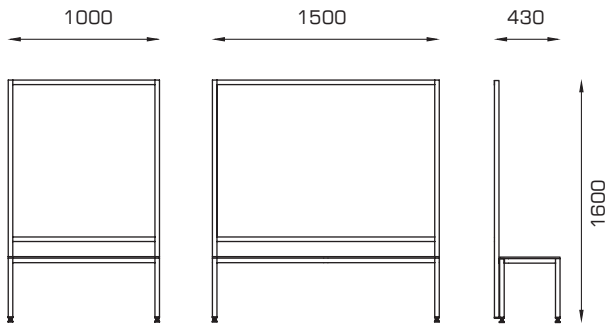

### Options - available for any model

### Option with low backrest

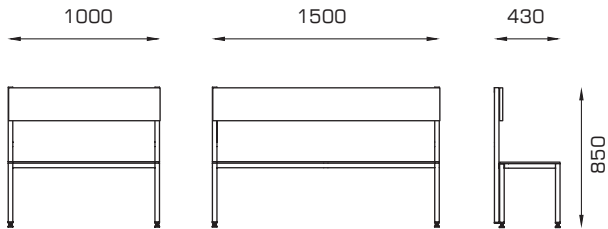

### Optional slat direction for seats

### Optional shoe shelf



## Upholstered benches

← back

### Elegance and comfort

The combination of a classic bench with elegant upholstery  
- beauty and elegance encapsulated in a simple minimalist  
form. Perfect for both modern and classical interiors.

### IRIS

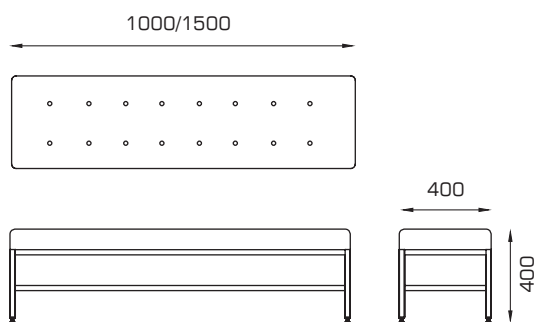

### LANDO

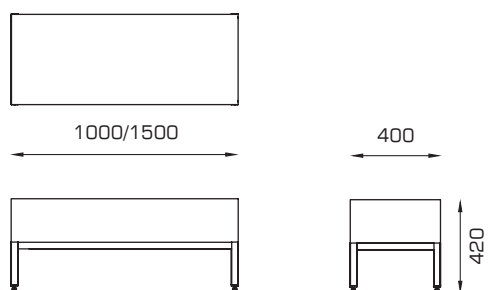

# Locks for lockers

**Security** - a common value of the locks we offer, that is why we only provide those from reputable manufacturers. Below, we describe three additional features that guided us in selecting the locks for our products.

**Waterproofness** - prepared to work in any conditions.

Prioritizing quality above all, we have decided that all locks offered by us are suitable for use in moist areas.

**Interchangeability** - lock models can be exchanged at any time, changing from a lower model to a higher one. This way, the locker room can be modernized without the need for costly door replacement. When changing locks to deposit or electronic locks, additional holes will have to be made in doors.

**Availability** - don't waste time waiting.

A strong aspect of our offer is the availability of locks on stock, significantly reducing the time needed to complete the order. For projects with slot or digital locks above 200 compartments, please contact us to confirm availability.

**Cam locks**, the locks we offer have a 1/1000 combination, meaning the chance of opening with your key any another locker is 0.1%.



**Padlock locks**, an alternative to key locks is padlocks. The recommended shackle diameter for padlocks is 5-7 mm.



## The option to use any lock.

We are not limited to our own selection; we can integrate the locker with any lock specified by the client.

**Code locks** are maintenance-free solutions. All code locks offered by us have a master key opening option in case the code is forgotten.



**Deposit locks**, Coin-operated or token-operated locks are capable of accepting coins or tokens into a special container. Locks can operate on coins of 1/2 EUR. In case of key loss, locks can be opened using a master key.



**Electronic lock** that support the standard RFID are modern programmable locks operated by CARDS, WRISTBANDS, or other RFID TOKENS. Available in both OFFLINE versions powered by batteries and ONLINE versions powered externally.





033

043

034



**LOXER transforms lockers into solutions**

ALSANIT introduces innovative solutions in the field of lockers with smart locks, enabling electronic control over them.

Thanks to cooperation with the renowned brand LOXER, representing the most advanced intelligent locking system available on the market, we can confidently offer this solution to our customers.

LOXER stands out not only for its ease of use but also for its rich configuration options, ensuring easy management and convenient use.



**The possibility of integration for any ALSANIT locker system**



**Full service including installation and training**



**The ability to integrate with the client's database**



**The ability to customize the software to individual needs**

**LOXER is an intelligent locker system that introduces a new era of facility management.**

**Examples of applications by industry**

**INDUSTRIES**

	OFFICES	SCHOOLS	STORES	PHARMACY	FACTORIES	SPORTS FACILITIES	LOGISTICS SHIPMENTS	HEALTHCARE	PUBLIC AREAS	GASTRONOMY
<b>FUNCTIONS</b>										
<b>STORAGE</b>	✓	✓				✓		✓	✓	✓
<b>DISPENSE</b>	✓	✓	✓	✓	✓	✓	✓	✓		
<b>DROP OFF / PICK UP</b>	✓	✓	✓		✓		✓		✓	
<b>CLOAKROOM</b>	✓	✓	✓		✓	✓	✓	✓	✓	✓

- Receive all your parcels from any carrier in one place.
- Effortlessly dispense workwear or distribute mail.
- Exchange documents or keys using easily managed lockers.
- Reduce costs by flexibly assigning users to lockers in the changing room.
- Control the circulation of tools or electronic equipment.
- Earn money by selling oversized items in hospitals, sports facilities, etc.

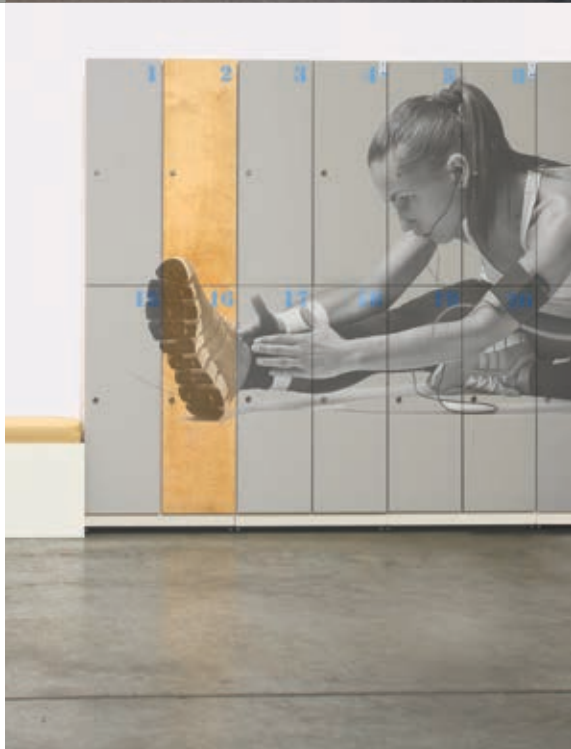





## The **STOCK** version - at no extra cost

Take advantage of our extensive stock collection of available HPL, MFC, and GLASS, as well as metal paint, and configure furniture at no extra cost. There are countless configuration possibilities.



## The **EXTENDED** Version - extra charge

If you would like to have the furniture bodies made in colors other than those originally designated for bodies, there is an additional surcharge of +15%.



## **BESPOKE** Version - custom color scheme upon individual request

In addition to non-standard board colors, we can also enrich the project with graphics or decals. If you wish for colors not available in our warehouse collection, you can choose any board color, paint, or decor from the available palette, and we will order it for you.

HPL + MFC - available from the ALSANIT board suppliers' collections  
PAINT FOR METAL + GLASS - available from the RAL color collection

# COLORS stock collection

## HPL

LOCKERS

HPL BUILT-INS

CUBICLES

CONTRACT FURNITURE

standard colors of locker bodies  
standard colors of Sandwich Panels

4,10,12 mm  
CLASSIC WHITE  
~ RAL 9016

4,10,12 mm  
PERFECT GREY  
~ RAL 7035

4,10,12 mm  
SILESIA N GREY  
~ RAL 7043

10 mm  
JUICY LEMON  
~ RAL 1016

10 mm  
JUICY ORANGE  
~ RAL 2004

10 mm  
RED DELUXE  
~ RAL 3020

10 mm  
FRESH GREEN  
~ RAL 6038

10,12 mm  
SHADOW GREY  
~ RAL 7042

10 mm  
CLASSIC BLACK  
~ RAL 9005

10 mm  
SPICE ORANGE  
~ RAL 2008

10 mm  
FOREST GREEN  
~ RAL 6018

10 mm  
EMERALD LAGUN  
~ RAL 5018

10 mm  
BLUE BAY  
~ RAL 5005

10 mm  
LION WOOD  
HORIZONTAL

colors available only for lockers and furniture

## METAL

LOCKERS

standard colors of locker bodies

PURE WHITE  
~ RAL 9010

PERFECT GREY  
~ RAL 7035

COAL GREY  
~ RAL 7016

JUICY ORANGE  
~ RAL 2004

RED HOT  
~ RAL 3000

FOREST GREEN  
~ RAL 6018

OCEAN BLUE  
~ RAL 5010

MARINA BLUE  
~ RAL 5015

CLASSIC BLACK  
~ RAL 9005

\* sample colors

**MFC**

LOCKERS

CUBICLES

CONTRACT FURNITURE

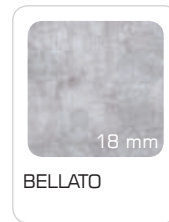
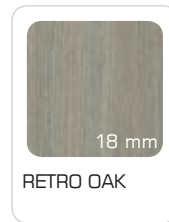
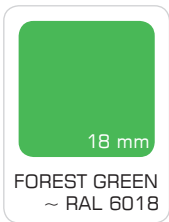
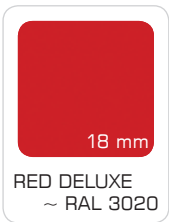
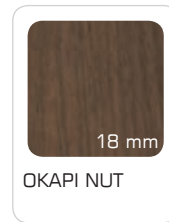
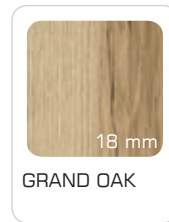
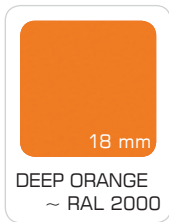
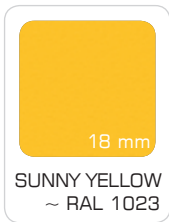
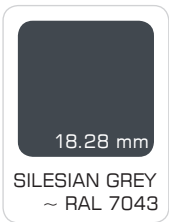
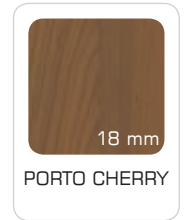
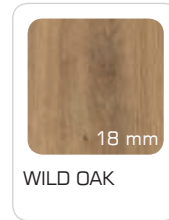
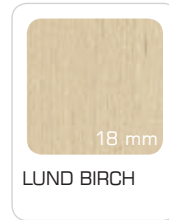
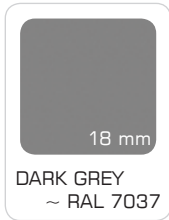
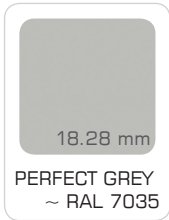
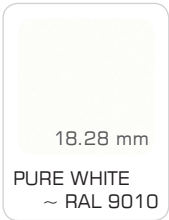

the color range is also available in the **HIGH GLOSS** version

**GLASS**

LOCKERS

CUBICLES

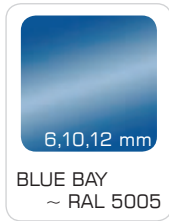
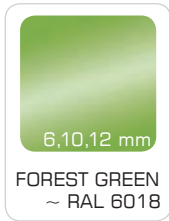
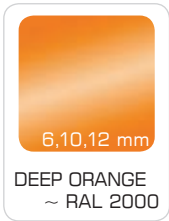
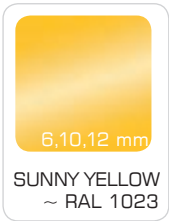
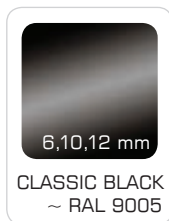
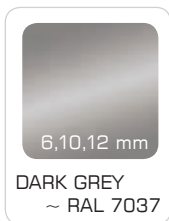
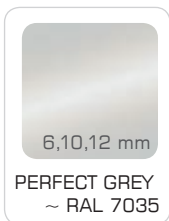
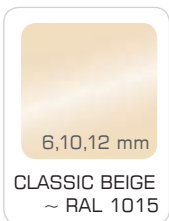
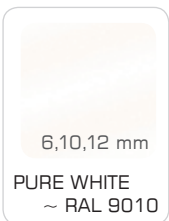

\* sample colors



**20+**

20 years of experience

**25+**

sales to over 25 countries

**2600+**

2600 projects annually

**8000+**

sqm of ALSANIT's hall space

**40000+**

doors produced annually

**LUXA lockers represent elegance in a simple form and a nod towards Scandinavian style.**

Thanks to a rich color palette, they allow for many possibilities in interior design.



ALSANIT®

Alsanit Sp. z o.o.  
ul. Wieleńska 2, 64-980 Trzcianka, POLSKA

+48 67 253 23 60  
alsanit@alsanit.pl  
www.alsanit.pl