



ALSANIT®



VITRAL

VITRAL

CE

VITRAL cubicles made of glass

Available in:

GLASS - Tempered glass

Optionally - partitions made of HPL

 Complementary products

page 6 →

Description:

VITRAL cabins are perfectly suited for exclusive interiors, providing an exceptional visual effect. They are made of double-layered, tempered glass, which is further laminated, allowing for color customization. The tempering process ensures aesthetics and safety, as the doors become hard and resistant to damage.

We understand that the devil is in the details, so all metal elements of cabins are precisely manufactured on our CNC machines. As a result, VITRAL ca-

bins are characterized not only by high aesthetics but also by excellent quality of workmanship.

It is worth noting that preparing the rooms for the installation of these cabins is crucial to achieve the best results. We recommend early contact and utilizing the support of the ALSANIT team during the planning and implementation stages. Glass enclosures require special attention to ensure an impressive end result.

 only Torx screws are used

 doors opening outward or inward

 hinges with gravity self-closing

 very high durability

 tailor made to individual dimensions



The most prestigious solutions



Aluminum fittings



Fittings developed by ALSANIT are manufactured in Poland at the company headquarters



Production on CNC machines ensures precision and short lead times

Standard dimensions

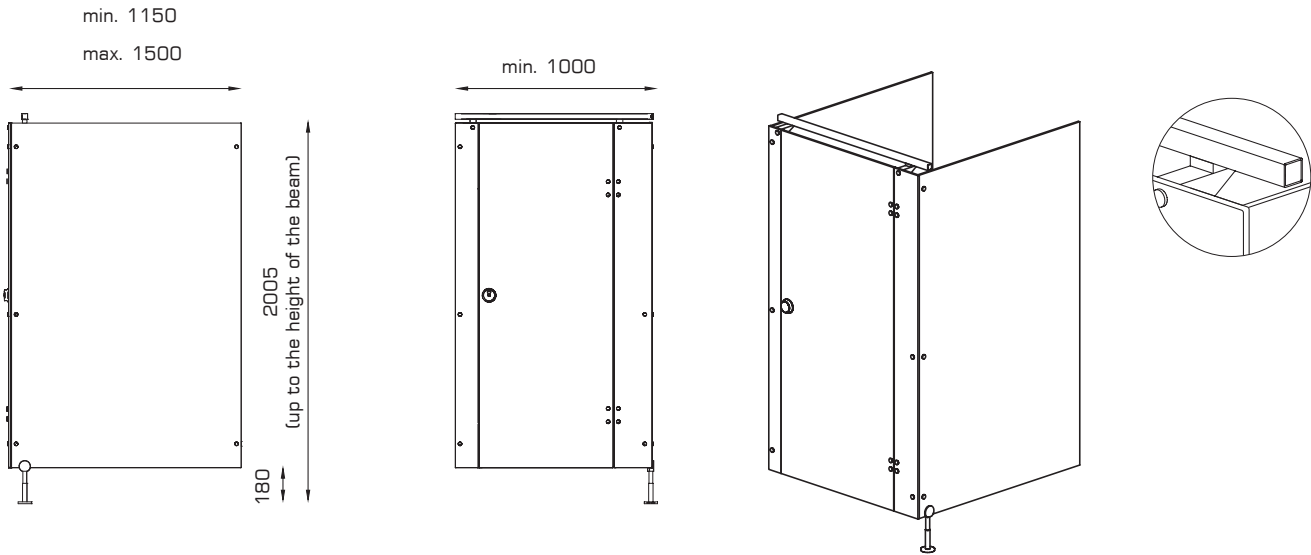

Standard equipment

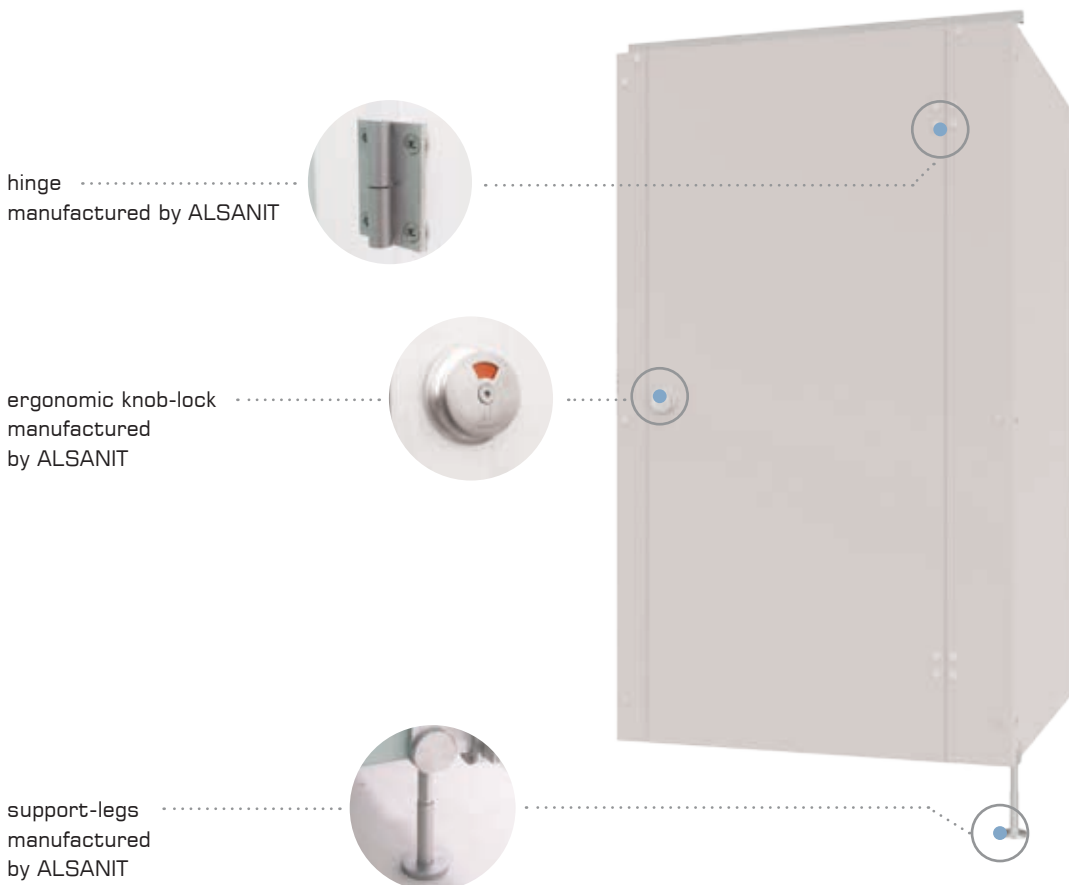

available colors



page 14 →

VITRAL construction details

Construction details:

Hinges

- front / rear mounted
- gravity self-closing
- durability: 200,000 open/closed cycles
- minimalist appearance

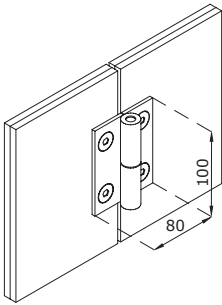

Knob-locks

- elegant, ergonomic and highly durable
- emergency opening capability
- universal for left/right doors
- bolt rotation angle of 360°
- „click“ every 90°
- easy to use, including for individuals with disabilities
- white-red occupancy indicator

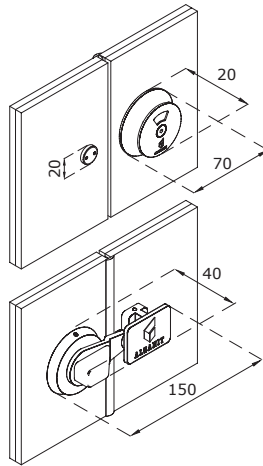

Support-legs

- effect of „hanging“ cabins
- recessed 15 cm into the cabin
- ensure easy leveling of partitions
- adjustment range +/- 20 mm to the floor
- rosette mounted on two dowels, covered with a plate

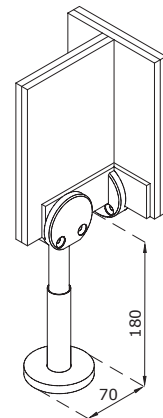

Panels available for the system:

GLASS

Tempered glass

10 mm

12 mm

Tempered glass available in a wide range of RAL colors. To ensure the highest quality of cabins, we use laminated glass. Each panel is constructed with two sheets.

- milled edges
- suitable for rooms with normal and high humidity
- possibility of custom graphics

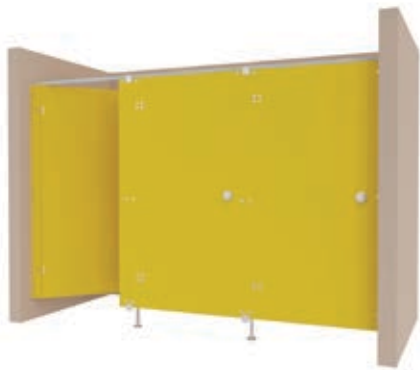

A solution for door frame



Support leg mounted on the partition wall



Rear-mounted beam



Wall and partition mounting with L brackets

VITRAL - a unique system for exceptional interiors

ALSANIT has the necessary expertise and machinery to offer such sophisticated solutions as the VITRAL system.

All metal fittings of the cabins are manufactured on our CNC machines. This ensures that VITRAL cabins have a unique character and are meticulously crafted in every aspect.





URINAL PARTITIONS

By using an aluminum rosette, we achieved an effect of exceptional lightness.

ALSANIT urinal partitions are installed using rosettes, eliminating the need for support legs.

available
colors



page 14 →



Urinal partitions

- Powder-coated rosette in a color close to RAL 7035
- Easy installation
- Minimalist appearance

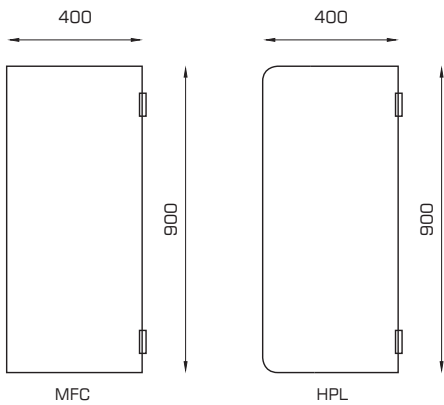

MFC

- 18 mm
- 28 mm

HPL

- 10 mm
- 12 mm

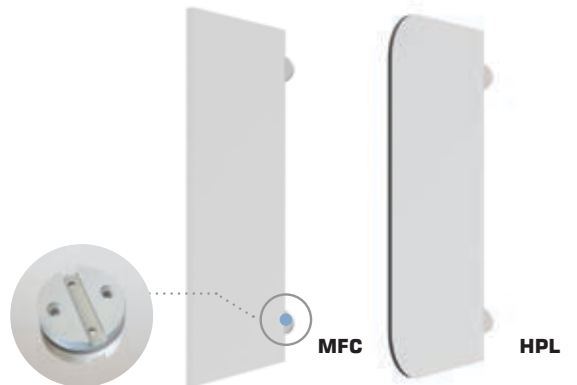



VANITY TOPS

Sink countertops are an important element of restroom furnishings.

Due to the direct exposure to water, they need to be made of durable materials and properly installed.

available
colors

page 14 →





Vanity tops

- preparation for sink installation
- all visible edges routed
- need for panel joining for countertops longer than 2600 mm
- optionally additional mirror frames matching countertops

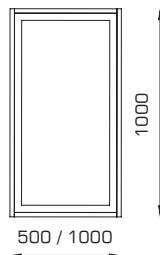
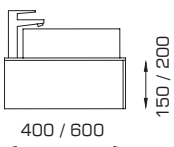
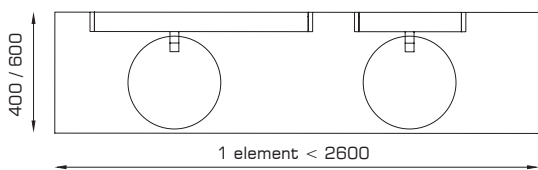

HPL

10 mm

12 mm





SHOWERS

Shower cubicles produced by ALSANIT are aesthetic, practical, and durable.

Thanks to the use of durable, and fully waterproof materials, ALSANIT shower cubicles are an investment for many years. Showers are typically made basing on the SOLARI system fittings.

available
colors



page 14 →

„I” partitions

- easy and fast installation
- curtain included

HPL

10 mm

12 mm

← back

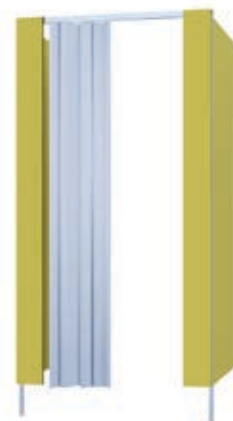
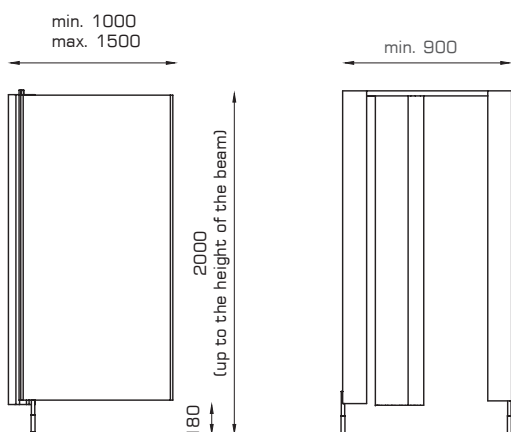

Showers „T” i „F”

- additional space for storing clothes
- curtain included

HPL

10 mm

12 mm

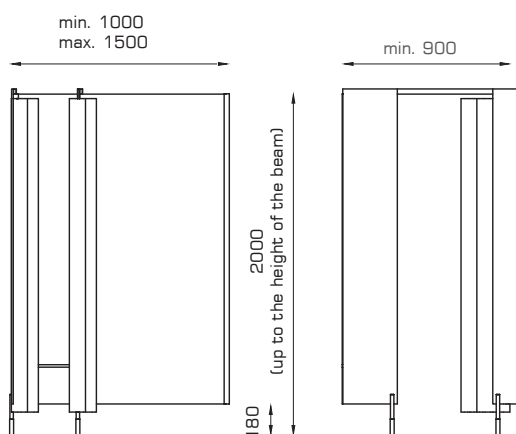

Showers with doors

- doors reinforced with ribs approximately 80 mm wide
- round profile for clothes or towel between the ribs

HPL

10 mm

12 mm

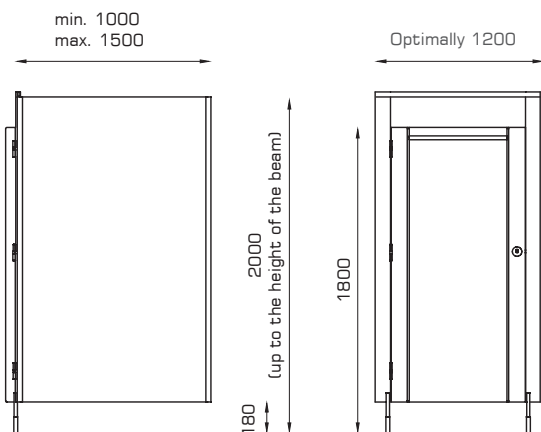



TECHNOWALL

Fast mounted and aesthetically pleasing wall claddings designed for large surfaces.

TECHNOWALL is a fully proprietary system of wall claddings with quick access to installations located behind them.

available
colors



page 14 →

HPL

- 10 mm
- 12 mm

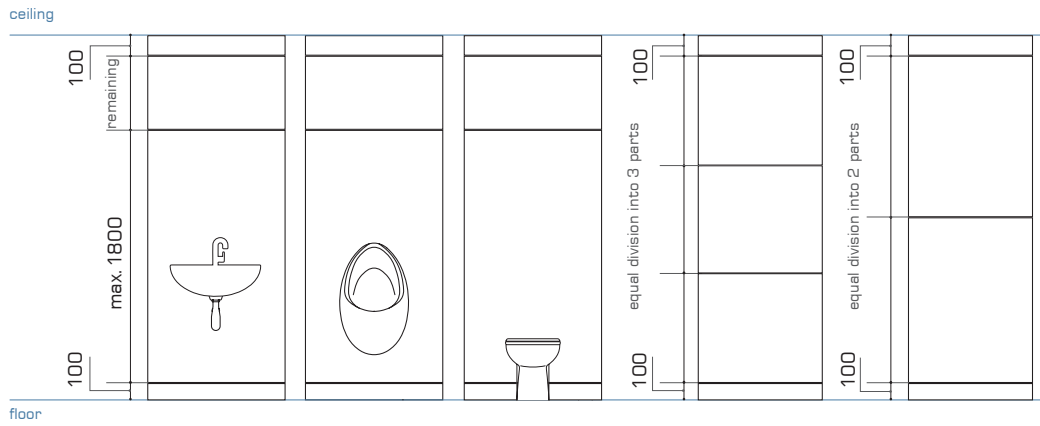

Installation:



1. Level and mount the bottom profile to the floor.

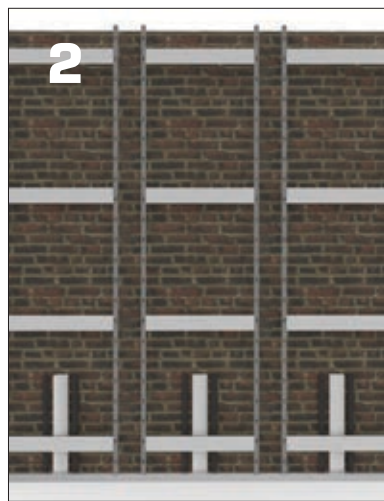

2. Place the steel frames for cladding on the profile, align, and attach them to the masonry wall.



3. Connect the frames with „shadow” panels. Mount masking panels at the bottom and top.



4. Fit the cladding panels up to the height of the utilities and fixtures. For the cladding where fixtures will be installed, cut openings for the connections/fixtures.

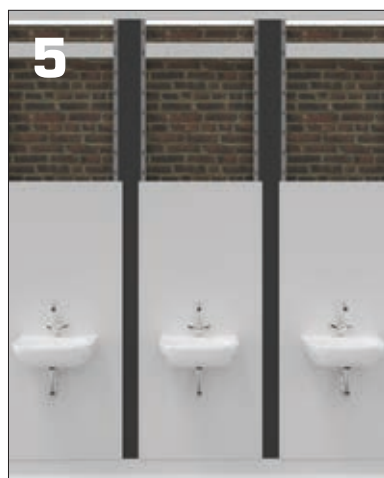

5. Secure and connect the fixtures to the cladding.



6. Install the remaining cladding.

COLORS stock collection

HPL







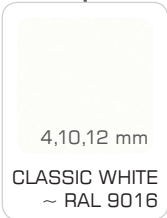
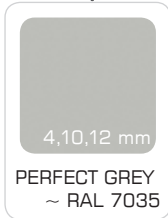
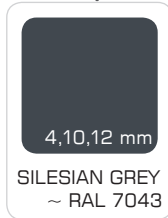

LOCKERS

HPL BUILT-INS

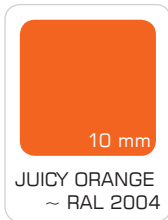
CUBICLES

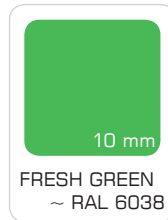
CONTRACT FURNITURE

standard colors of locker bodies
standard colors of Sandwich Panels

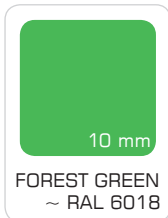
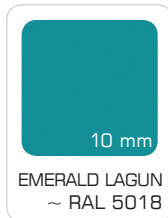
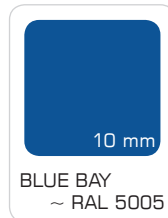
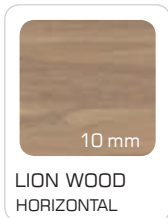
 <p>4,10,12 mm CLASSIC WHITE ~ RAL 9016</p>	 <p>4,10,12 mm PERFECT GREY ~ RAL 7035</p>	 <p>4,10,12 mm SILESIA N GREY ~ RAL 7043</p>			
 <p>10 mm JUICY LEMON ~ RAL 1016</p>	 <p>10 mm JUICY ORANGE ~ RAL 2004</p>	 <p>10 mm RED DELUXE ~ RAL 3020</p>	 <p>10 mm FRESH GREEN ~ RAL 6038</p>	 <p>10,12 mm SHADOW GREY ~ RAL 7042</p>	 <p>10 mm CLASSIC BLACK ~ RAL 9005</p>
 <p>10 mm SPICE ORANGE ~ RAL 2008</p>	 <p>10 mm FOREST GREEN ~ RAL 6018</p>	 <p>10 mm EMERALD LAGUN ~ RAL 5018</p>	 <p>10 mm BLUE BAY ~ RAL 5005</p>		
				 <p>10 mm LION WOOD HORIZONTAL</p>	

colors available only for lockers and furniture

METAL

LOCKERS

standard colors of locker bodies

 <p>PURE WHITE ~ RAL 9010</p>	 <p>PERFECT GREY ~ RAL 7035</p>	 <p>COAL GREY ~ RAL 7016</p>			
 <p>JUICY ORANGE ~ RAL 2004</p>	 <p>RED HOT ~ RAL 3000</p>	 <p>FOREST GREEN ~ RAL 6018</p>	 <p>OCEAN BLUE ~ RAL 5010</p>	 <p>MARINA BLUE ~ RAL 5015</p>	 <p>CLASSIC BLACK ~ RAL 9005</p>

* sample colors

MFC

LOCKERS

CUBICLES

CONTRACT FURNITURE

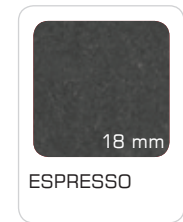
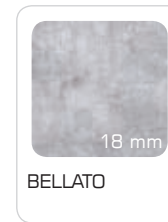
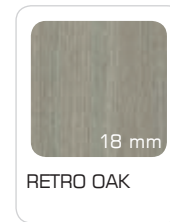
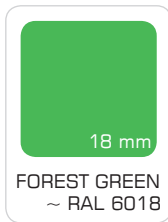
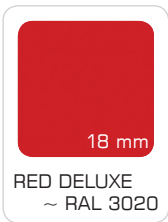
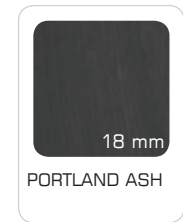
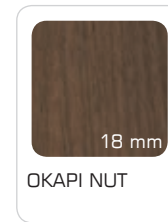
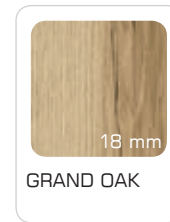
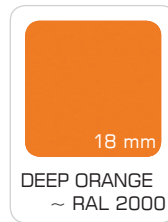
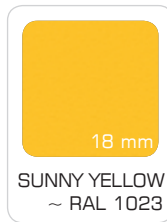
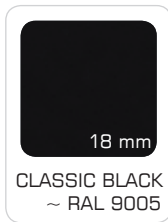
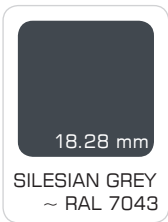
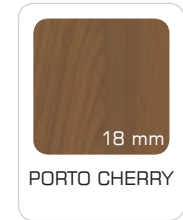
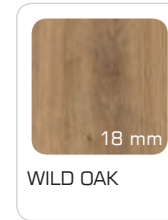
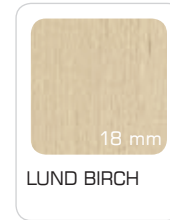
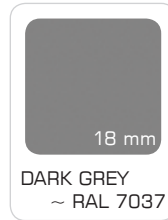
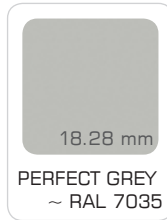
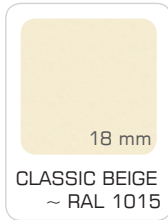
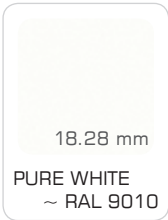

the color range is also available in the **HIGH GLOSS** version

GLASS

LOCKERS

CUBICLES

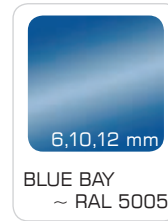
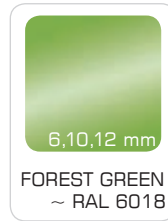
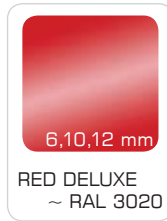
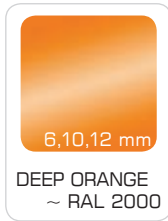
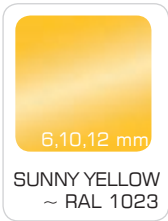
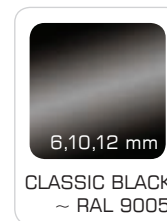
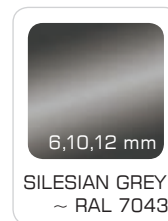
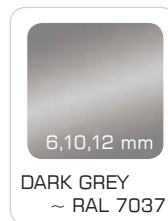
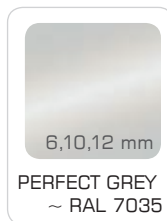
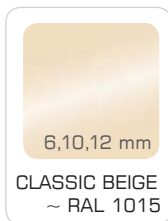
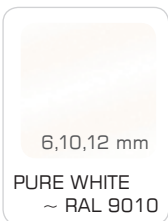

* sample colors

20+

20 years of experience

25+

sales to over 25 countries

2600+

2600 projects annually

8000+

sqm of ALSANIT's hall space

40000+

doors produced annually

VITRAL perfectly fits into the trends of 21st-century architecture, where glass plays a key role.

Fittings refined in every detail complement the prestigious appearance.



ALSANIT®

Alsanit Sp. z o.o.
ul. Wieleńska 2, 64-980 Trzcianka, POLSKA

+48 67 253 23 60
alsanit@alsanit.pl
www.alsanit.pl